

# 1865 Megohmmeter/IR Tester

## Instruction Manual

Form 150073/D4

©QuadTech, Inc., 1992  
5 Clock Tower Place, 210 East  
Maynard, Massachusetts, U.S.A. 01754  
September, 2003

Telephone	978-461-2100
Sales	800-253-1230
Facsimile	978-461-4295
Website	<a href="http://www.quadtech.com">www.quadtech.com</a>

The material in this manual is for informational purposes only and is subject to change, without notice. QuadTech assumes no responsibility for any error or for consequential damages that may result from the misinterpretation of any procedures in this publication.

### **WARNING**

Potentially dangerous voltages may be present on front and rear panel terminals. Follow all warnings in this manual when operating or servicing this instrument. Dangerous energy levels may be stored in capacitors tested by this unit. Always make sure the high voltage indicator is not on when connecting or disconnecting the unknown.



Product will be marked with this symbol (ISO#3684) when it is necessary for the user to refer to the instruction manual in order to prevent injury or equipment damage.



Product marked with this symbol (IEC417) indicates presence of direct current.



Product will be marked with this symbol (ISO#3684) when voltages in excess of 1000V are present.



---

# Contents

---

<b>Warranty</b>	<b>7</b>
<b>Specifications</b>	<b>9</b>
<b>Accessories</b>	<b>11</b>
<b>Safety Precautions</b>	<b>13</b>
<b>Condensed Operating Instructions</b>	<b>15</b>

## **Introduction - Section 1**

1.1	Unpacking and Inspection	21
1.2	Product Overview	21
1.3	Controls and Indicators	22
	1.3.1 Front Panel Controls and Indicators	22
	1.3.2 Rear Panel Controls and Connectors	24
1.4	Installation	25
	1.4.1 Dimensions	25
	1.4.2 Instrument Positioning	25
	1.4.3 Power Requirements	25
	1.4.4 Safety Inspection	27

## **Operation - Section 2**

2.1	Terms and Conventions	29
2.2	Startup	29
2.3	Zeroing	30
2.4	Connection to Device Under Test	30
2.5	Measurement Procedure	32
	2.5.1 General	32
	2.5.2 Default Measurement Conditions	33
	2.5.3 Automatic Measurement Mode	34
	2.5.4 Manual Measurement Mode	36
2.6	Menu Functions	36
	2.6.1 General	36
	2.6.2 Setup Menu	37
	2.6.2.1 Voltage	37
	2.6.2.2 Charge Time	38
	2.6.2.3 Dwell Time	38
	2.6.2.4 Measure Time	38
	2.6.2.5 Discharge Time	39
	2.6.2.6 Mode	39
	2.6.2.7 Range	40
	2.6.2.8 Limit	43
	2.6.2.9 Stop on Pass	44
	2.6.2.10 # to Average	44

---

## Contents (Continued)

---

### Operation - Section 2 (Continued)

2.6.3	I/O Menu .....	45
2.6.3.1	Display Type .....	45
2.6.3.2	Result Format.....	46
2.6.3.3	RS-232 .....	47
2.6.3.4	IEEE-488.....	48
2.6.3.5	Handler.....	48
2.6.3.6	Results to Floppy .....	48
2.6.4	Utilities Menu .....	50
2.6.4.1	Save Setup.....	51
2.6.4.2	Recall Setup .....	53
2.6.4.3	Zero .....	54
2.6.4.4	Lock Out .....	55
2.6.4.5	Calibration.....	55
2.6.4.6	Set Time/Date .....	56
2.6.4.7	Elapsed Time .....	57
2.6.4.8	Calibration Date .....	57
2.6.4.9	Set Contrast.....	58
2.6.4.10	LCD Backlite .....	58
2.7	Input/Output Interface.....	58
2.7.1	I/O Interface .....	58
2.7.2	IEEE-488 Interface.....	60
2.7.3	Sample Program for National Instruments GPIB Card.....	65
2.7.4	Sample Program for IO Tech GPIB Card .....	66
2.7.5	RS232 Interface.....	67
2.7.6	Sample Program for RS232 .....	68
2.7.7	Results to Printer.....	69
2.8	Error Messages.....	70

### Applications - Section 3

3.1	Insulation Resistance Testing.....	73
3.2	Test Sample Resistivity Measurements .....	74
3.3	Capacitor Insulation Resistance .....	74
3.3.1	General .....	74
3.3.2	Charge Time Constant .....	75
3.3.3	Discharge Time .....	76
3.4	Resistance Measurements .....	76
3.5	Measurement of Voltage Coefficient.....	76
3.6	Guarded, 3 Terminal Measurements.....	77

---

## Contents (Continued)

---

### **Theory Section 4**

4.1	General .....	79
4.2	Instrument Description.....	79
4.2.1	Basic I2000 Instrument Architecture .....	79
4.2.2	1865 Instrument Modules .....	80
4.2.3	I2000 Instrument Options .....	81

### **Maintenance/Calibration - Section 5**

5.1	General .....	83
5.2	Instrument Return .....	83
5.3	Routine Maintenance .....	83
5.3.1	Battery Replacement .....	84
5.3.2	Resetting of Time and Date .....	85
5.3.3	Loss of Display Contrast.....	85
5.3.4	Preventive Maintenance/Cleaning .....	86
5.4	Calibration.....	86
5.4.1	General .....	86
5.4.2	Calibration Procedure .....	86



---

## Warranty

---



QuadTech warrants that Products are free from defects in material and workmanship and, when properly used, will perform in accordance with QuadTech's applicable published specifications. If within one (1) year after original shipment it is found not to meet this standard, it will be repaired, or at the option of QuadTech, replaced at no charge when returned to a QuadTech service facility.

**Changes in the Product not approved by QuadTech shall void this warranty.**

**QuadTech shall not be liable for any indirect, special or consequential damages, even if notice has been given of the possibility of such damages.**

**This warranty is in lieu of all other warranties, expressed or implied, including, but not limited to any implied warranty or merchantability or fitness for a particular purpose.**

### **SERVICE POLICY**

QuadTech's service policy is to maintain product repair capability for a period of at least five (5) years after original shipment and to make this capability available at the then prevailing schedule of charges.





---

## Specifications

---

**Resistance Range:**  $1 \times 10^3$  to  $> 1 \times 10^{14} \Omega$  (dependent on test voltage)  
 $1 \times 10^6 - > 1 \times 10^{14} \Omega$  at 1000VDC  
 $1 \times 10^5 - 1 \times 10^{13} \Omega$  at 100VDC  
 $1 \times 10^4 - 1 \times 10^{12} \Omega$  at 10VDC  
 $1 \times 10^3 - 1 \times 10^{11} \Omega$  at 1VDC

(7 ranges or auto ranging)

**Resistance Accuracy:\***  $\pm[0.45\% + \{(R_x/V_x)(0.0005 \text{ FS} + 2\text{pA}) + 30\Omega/R_x\}100\%]$

R<sub>x</sub>: Measured resistance in ohms

V<sub>x</sub>: Programmed voltage in volts

FS: Full scale current range in amperes

**Voltage Range:** 1 to 1000, Volts programmable in two ranges

**Voltage Accuracy:\*** 1 - 100V: 1% of setting +1V  
25mV resolution  
100 - 1000V: 1% of setting +2V  
250mV resolution

### Output Voltage

**Impedance:**  $1 \text{ k}\Omega \pm 5\%$

**Current Limited:**  $< 2\text{mA}$

**Current Measure:**  $1 \times 10^{-13}$  to  $1 \times 10^{-3}$  amps

**Current Accuracy:\*** 1nA to 1mA:  $\pm[0.5\% + (0.0005\text{FS} + 2\text{pA})]$   
100pA to 1nA:  $\pm[1\% + (0.0005\text{FS} + 2\text{pA})]$   
1pA to 100pA:  $\pm[10\% + (0.0005\text{FS} + 2\text{pA})]$

**Input Impedance:**  $5 \text{ k}\Omega \pm 5\%$

**Measure Limits:** Pass/Fail (1 limit)

**Display:** LCD graphic display  
Voltage warning indicator  
Pass/Fail indicator

\* specified at front panel connectors

---

## Specifications (Continued)

---

<b>Test Cycle:</b>	Manual: Charge, Measure, Discharge Automatic: Charge time: 0 -300 sec Dwell time: 0 - 300 sec Measure time: 0 - 300 sec (0 – 999 on later units) Discharge time: 0 - 300 sec
<b>I/O Interface:</b>	Standard -RS232 I/O Port (w/safety interlock) Optional -1865-01 - IEEE-488, factory installed at unit purchase 1865-02 - Floppy Drive, 3.5", factory installed only 1865-03 - Rear panel input terminals, factory installed at purchase 1865-70 - IEEE-488, field retrofit
<b>Input Terminals:</b>	Four sheathed banana plugs, front or rear mount (optional) + unknown (red)                      - unknown (black) guard (blue)                              ground (green)
<b>Dimensions:</b>	Bench with tilt back bail (133.4mm high x 444.5mm wide x 406.4mm deep) (5 1/4" x 17 1/2" x 16")
<b>Weight:</b>	Approximately 8.2 kg (18 lbs) - Net Approximately 11.8 kg (26 lbs) - Shipping
<b>Environmental:</b>	MIL-T-28800D, Type 3, Class 5, Style E & F Operating: 0°C to 50°C, stated accuracy <45% RH Storage: -40°C to 71°C Altitude: <2000m, Installation Category 1, Pollution Degree 1
<b>Power:</b>	• 90 - 250V    • 47 - 63Hz    • 40W max
<b>General:</b>	• Fully programmable via menu • Zeroing • Stored test conditions and results • Selected measurement units (engineering or scientific)
<b>Accessories Supplied:</b>	• Instruction Manual                      • AC Power Cable • Calibration Certificate                • 1 MΩ and 100 kΩ Capacitor Adapters • Interlock Connector
<b>Accessories Available:</b>	• 1865-50 Rack Mount Kit                      • 1865-51 Shielded Lead Set • 1865-52 Component Test Fixture

---

## Accessories

---

### Accessories Included

<b>Item</b>	<b>Quantity</b>	<b>QuadTech P/N</b>
U.S. AC Power Cable (3-prong)	1	4200-0300
T2.5A 250V 5X20mm Line Fuse	1	520049
1M $\Omega$ Capacitor Adaptor	1	800015
100k $\Omega$ Capacitor Adaptor	1	800014
Interlock Connector	1	630019
Instruction Manual	1	150073
Calibration Certificate	1	N/A

### Accessories/Options Available

<b>Item</b>	<b>Quantity</b>	<b>QuadTech P/N</b>
IEEE-488 Interface (factory installed)	1	1865-01
3.5" Floppy Drive Option (factory installed)	1	1865-02
Rear Panel Input Option (factory installed)	1	1865-03
Rack Mount Kit	1	1865-50
Shielded Lead Set	1	1865-51
Component Test Fixture	1	1865-52
IEEE-488 Interface (Field Retro-Fit Option)	1	1865-70



---

## Safety Precautions

---

**The 1865 Megohmmeter/IR Tester can provide an output voltage as high as 1000VDC to the external device under test (DUT).**

**Although the 1865 unit is designed with full attention to operator safety, serious hazards could occur if the instrument is used improperly and these safety instructions are not followed.**

1. The 1865 unit is designed to be operated with its chassis connected to earth ground. The 1865 instrument is shipped with a three-prong power cord to provide this connection to ground. The power cord should only be plugged in to a receptacle that provides earth ground. Serious injury can result if the Sentry unit is not connected to earth ground.
2. Tightly connect cable(s) to the (green) **GND** terminal. If this is not done, the DUT's casing can be charged to the high voltage test level and serious injury or electrical shock hazards could result if the DUT is touched.
3. Never touch the metal of the High Voltage probe directly. Touch only the insulated parts of the lead(s).
4. Never touch the test leads, test fixture or DUT in any manner (this includes insulation on all wires and clips) when the high voltage is applied and the red **CAUTION HIGH VOLTAGE LED** is lit.
5. Before turning on the 1865 unit, make sure the AC power cord is plugged into the proper voltage source and that there is no device (DUT) or fixture connected to the test leads.
6. After each test, press the **[STOP]** (red) button for safety. This terminates the high voltage being applied to the output terminals.
7. When the **CAUTION HIGH VOLTAGE LED** is lit NEVER touch the device under test, the lead wires or the output terminals.
8. Before touching the test lead wires or output terminals make sure:
  - a) The red **[STOP]** button has been pressed.
  - b) The **CAUTION HIGH VOLTAGE LED** is OFF.
  - c) The output voltage display is 0 (zero).
9. **In the case of an emergency**, turn OFF the [POWER] switch using a "hot stick" and disconnect the AC power cord from the wall. **DO NOT TOUCH THE 1865 INSTRUMENT.**
10. If the **CAUTION HIGH VOLTAGE LED** does not go **off** when the **[STOP]** button is pressed, immediately stop using the tester. It is possible that the output voltage is still being delivered regardless of the TEST ON/OFF control signal.
11. When the 1865 instrument is used in remote control mode, be extremely careful. The High Voltage Output is being turned on and off with an external signal.



---

## Condensed Operating Instructions

---

### WARNING

High voltage is applied to the measurement terminals of the 1865 any time the **CAUTION HIGH VOLTAGE** LED is **ON**. While the current from the instrument is limited, the energy stored in a capacitive device connected to the terminals may be lethal. Always make sure the high voltage indicator is **OFF** when connecting or disconnecting the unknown. A flashing **CAUTION HIGH VOLTAGE** light and/or **DANGER** on the display indicates a defective unit with dangerously high voltages possible at the input terminals. Power the unit down and do not use.

### General Information

The 1865 Megohmmeter/IR Tester is a computer controlled measuring instrument for direct readout of resistance and current. The voltage applied to the device under test (DUT) is programmable from 1 to 1000 volts. A pass/fail indicator provides a visual display of test results based on a preset limit. A set of power-up default test conditions are stored in the unit and are as set by the factory (1V, test times zero) until reprogrammed by the user.

### Start-up

The 1865 can be operated from a power source between 90V and 250V AC at a power line frequency of 47 to 63 Hz. The standard 1865 is shipped from the factory with a 2.5A fuse in place for 115V or 220V operation. To change the fuse refer to paragraph 1.4.3.

Connect the instrument power cord to the source of proper voltage.

### IMPORTANT

**The interlock connector (included with the unit) needs to be installed on the rear panel I/O Port connector if the interlock function is not being used. When the 3.5" Floppy Drive Option is present ALWAYS MAKE SURE NO DISKS ARE INSTALLED WHEN THE UNIT IS POWERED UP, otherwise information stored on the disks could be lost.**

Press the [POWER] button on the front panel to apply power. To switch power off press the [POWER] button again or if measurements are to be made proceed with Zeroing the instrument, discussed in the next paragraph.

---

## Condensed Operating Instructions

---

### Zeroing

Before measuring, zero out test lead or fixture measurement errors as follows.

1. If test leads are to be used connect them to the 1865 input terminals, red to + unknown, black to - unknown, with probes open and spaced some distance apart (or fixture open).
2. Press **[MENU]** key to select menu display.
3. Press **Right or Left Arrow** key to select Utilities menu.
4. Press **Up or Down Arrow** key to select Zero in the sub menu.
5. Press **[ENTER]** key to activate the Zero routine and follow instructions on the instrument display.

### Auto Measurement Mode

In automatic mode, once the **[START]** button is depressed the instrument sequences automatically through the test cycle phases, charge, dwell, measure and discharge and a pre-stored set of test conditions are executed. These test conditions can be **DEFAULT** (those at power up), set using menus or the operator can recall a previously stored setup.

1. Connect the device under test to the 1865 test leads or other fixture being used.
2. If the desired setup conditions are anything other than **DEFAULT**, set using menus or proceed to **Recalling Setups** below before continuing with step 3.
3. Initiate the auto measurement mode by pressing **[START]**. The High Voltage Indicator will remain on as the unit sequences automatically through all four phases (charge, dwell, measure, discharge) of the test cycle.
4. The measurement can be aborted at any time during the test cycle by pressing **[STOP]**.
5. Once the High Voltage Indicator goes off the measurement is complete, the final result remains displayed and the device can be removed.



---

# Condensed Operating Instructions

---

## Manual Measurement Mode

In manual measurement mode each phase of a test cycle, charge, measure and discharge is initiated manually at the users discretion. These test conditions can be DEFAULT (those at power up), set using menus or the operator can recall a previously stored setup.

1. Connect the device under test to the 1865 test leads or other fixture being used.
2. Press **[MENU]** key to select menu display.
3. Press **Right or Left Arrow** key to select Setup menu.
4. Press **Up or Down Arrow** key to select Mode in the sub menu.
5. Press **[ENTER]** to activate the selection field.
6. Press **Right or Left Arrow** key to select Manual and press **[ENTER]**.
7. If the desired setup conditions are anything other than DEFAULT, set using menus or proceed to Recalling Setups below before continuing with step 8. (Setup measurement times are ignored in manual mode).
8. Initiate the charge phase by pressing **[START]** to apply high voltage to the device. The High Voltage Indicator will remain on as long as a voltage is applied. The measurement can be aborted at any time during the test cycle by pressing **[STOP]**.
9. Initiate a single measurement by pressing **[START]** again, The measured result will be displayed on the LCD and will be updated each time **[START]** is pressed.
10. To discharge the device press **[STOP]**.
11. Before removing the device press **[STOP]** again to end the discharge phase and turn the High Voltage Indicator off.

## Recalling Setups

1. To recall a set of test conditions previously stored:
    - Press **[MENU]** key to select menu display.
    - Press **Right or Left Arrow** key to select Utilities menu.
    - Press **Up or Down Arrow** key to select Recall Setup.
    - Press **[ENTER]** key to activate the recall entry field.
    - Press **Up or Down Arrow** key to select the desired setup. choices are:
      - DEFAULT, if conditions are power up which can be changed by the user.
      - FLOPPY, if setup is to be recalled from the optional floppy drive.
        - Setup Name stored in the instrument internal memory or floppy.
- Once the desired setup is located press **[ENTER]** key to finalize recall of the setup conditions.

---

## Condensed Operating Instructions

---

### Saving Setups

1. To save the current set of test conditions as entered (conditions include, voltage, test times, measurement range, limit, and display modes):
  - Press **[MENU]** key to select menu display.
  - Press **Right or Left Arrow** key to select Utilities menu.
  - Press **Up or Down Arrow** key to select Save Setup.
  - Press **[ENTER]** key to activate setup entry field.
  - Press **UP or Down Arrow** key to select the desired setup, choices are:
    - NEW, if a setup is to be saved in instruments internal memory.
    - DEFAULT, if conditions at power up are to be changed and restored.
    - FLOPPY, if a new setup is to be stored or existing one changed on the floppy.
    - Setup Name if an existing set of conditions are to be changed in the instrument internal memory or floppy.
  - Press **[ENTER]** key to activate the Save entry field selected above.
  - If NEW is selected (internal memory or floppy) enter the desired identifying name, **up to 8 characters**, under which these set of test conditions will be stored.
  - Press **[ENTER]** key to finalize storage of the setup conditions or if DEFAULT is selected one must answer Y or N to overwrite.

### Changing Test Voltage

1. Set the desired test voltage:
  - Press **[MENU]** key to select menu display.
  - Press **Right or Left Arrow** key to select Setup menu.
  - Press **Up or Down Arrow** key to select Voltage.
  - Press **[ENTER]** key to activate the voltage entry field.
  - Enter desired test voltage (up to 5 digits with decimal) **between 1 and 1000V**.
  - Press **[ENTER]** key to finalize the voltage entry.

### Changing Measurement Times

1. To set the desired measurement cycle times, charge, dwell, measure and discharge:
  - Press **[MENU]** key to select menu display.
  - Press **Right or Left Arrow** key to select Setup Menu.
  - Press **Up or Down Arrow** key to select desired time: charge, dwell, measure or discharge.
  - Press **[ENTER]** key to activate the corresponding time entry field.
  - Enter the desired time between 0 and 300 seconds(measure, 0 – 999 on later units)
  - Press **[ENTER]** key to finalize the time entry.
2. Continue to set the other times as desired by repeating step 1.

---

## Condensed Operating Instructions

---

### Setting Pass/Fail Limit

1. To enter a single measurement limit for resistance or current (depending on results display selected):
  - Press **[MENU]** key to select menu display.
  - Press **Right or Left Arrow** to select Setup menu.
  - Press **Up or Down Arrow** key to select Limit in sub menu.
  - Press **[ENTER]** key to activate the limit entry field.
  - Enter the **numerical value** (up to 4 digits plus decimal point) of the limit desired, then enter the **exponential value** after first pressing the **e** select key (use minus exponential value for current).
  - Press **[ENTER]** key to finalize the limit entry.

### Changing Display Type and Units

1. To change displayed measurement results between Resistance, Current or Pass/Fail:
  - Press **[MENU]** key to select menu display.
  - Press **Right or Left Arrow** key to select I/O Menu.
  - Press **Up or Down Arrow** key to select Display.
  - Press **[ENTER]** key to activate the selection field.
  - Press **Up or Down Arrow** key to select desired measurement results, Resistance, Current or Pass/Fail if a limit is to be used.
  - Press **[ENTER]** key to finalize the entry.
2. To change the measurement results format between Scientific or Engineering units:
  - Press **[MENU]** key to select menu display.
  - Press **Right or Left Arrow** key to select I/O Menu.
  - Press **Up or Down Arrow** key to select Result Format.
  - Press **[ENTER]** key to activate the selection field.
  - Press **Right or Left Arrow** to select desired results format, Sci for Scientific or Eng for Engineering.
  - Press **[ENTER]** key to finalize the entry.



---

## Section 1: Introduction

---

### **WARNING**

High voltage is applied to the measurement terminals of the 1865 anytime the **CAUTION HIGH VOLTAGE** LED is **ON**. While the current from the instrument is limited to a value that is not dangerous under most conditions, the energy stored in a capacitor connected to the terminals may be lethal. Always make sure the **CAUTION HIGH VOLTAGE** LED is **OFF** when connecting or disconnecting the unknown.

### **1.1 Unpacking and Inspection**

Inspect the shipping carton before opening. If the carton is damaged, contact the carrier agent immediately. Inspect the 1865 instrument for any damage. If the instrument appears damaged or fails to meet specifications notify QuadTech (refer to instruction manual front cover) or its local representative. Retain the shipping carton and packing materials for future use such as returning for recalibration or service.

### **1.2 Product Overview**

The 1865 Megohmmeter/IR Tester is a general purpose high voltage instrument for resistance measurements on insulating materials and components. It is designed for easy, accurate and direct readings of high resistance typically found in synthetic resins, porcelains, insulating oils, plastics and other similar materials. It is also used for measurements on capacitors, transformers, switches, cables and connectors. The 1865 provides a direct readout of resistance from  $1000\Omega$  to  $1000T\Omega$  with fully automatic ranging. The voltage applied to the unknown is programmable from 1V to 1000V.

The 1865 includes a high resolution graphics display and keypad for ease of use. The test cycle is fully automatic with programmable charge, dwell, measure and discharge times. These times, along with other test conditions can be stored in instrument memory and recalled for later use. A pass/fail indicator provides the operator with a visual indication based on a preset resistance limit. The unit also contains automatic zeroing at the test leads as well as built-in self-test routines. Safety features include current limiting to less than 2mA and a front panel indication when voltage is applied to the test terminals, thus permitting connections to be made safely.

The 1865 comes standard with I/O Port (handler) and RS232 interface. An IEEE-488 interface is optional for communication with other instrumentation and remote control operation. A 3 1/2" floppy drive option is also available for storing test conditions and results. There is a direct reading current measurement mode from 1mA to 1pA.

The unit is available with front or rear panel input connections with guard and ground terminals to permit measurements of grounded or ungrounded devices.

## 1.3 Controls and Indicators

### 1.3.1 Front Panel Controls and Indicators

Figure 1-1 shows the controls and indicators on the front of the 1865 unit. Table 1-1 identifies them with description and function.

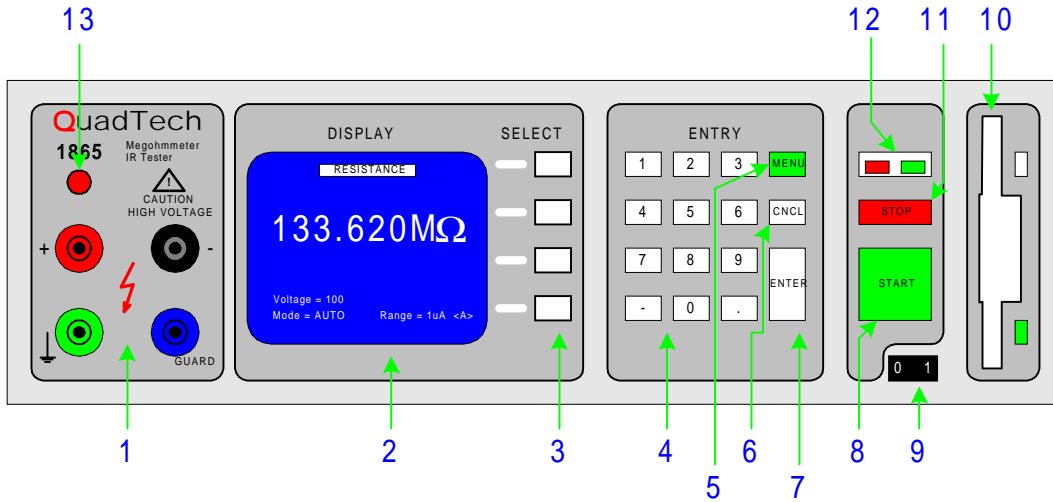

**Figure 1-1: Front Panel Controls & Indicators**

**Table 1-1: Front Panel Controls and Indicators**

Reference Number Figure 1-1	Name	Type	Function
1	Input Panel		Connection for device under test (DUT)
1a	GROUND	Green Sheathed Banana Plug	Ground Terminal for jumper of (+) Input Terminal or Guard Input to Chassis GND
1b	+	Red Sheathed Banana Plug	High Voltage Terminal for connection to DUT
1c	-	Black Sheathed Banana Plug	Low Voltage Terminal for connection to DUT
1d	GUARD	Blue Sheathed Banana Plug	Guard Terminal for 3-Lead Guarded Measurements
2	Display	LCD Graphic	Displays measurement results, instrument status and user interface menus.
3	SELECT	4 Gray Push Buttons	Function as indicated on adjacent display From top to bottom: functions as: Up (↑), Down (↓), Right (→) or Left (←) during Menu Selection. Other functions include: measurement units, exponent, Yes or No and del (delete).
4	Keypad	White Push Buttons	12 keys for making numerical entries: 0-9, decimal point and minus sign.

**Table 1-1: Front Panel Controls and Indicators (Continued)**

5	MENU	Green Push Button	Press to enter menu display mode or press to exit sub menu & return to main menu.
6	CNCL	Gray Push Button	To exit menu mode with no parameter changes made or to exit current field
7	ENTER	Gray Push Button	To switch user to entry mode or to accept menu entry as entered.
8	START	Green Push Button	To initiate the measurement
9	POWER	Black Toggle Switch	To apply power to the instrument: 1 = ON, 0 = OFF
10	OPTION	3 ½ “ Floppy Drive	To store test setup conditions and measurement results. High Density (HD: 1.44M) or Low Density (LD: 720k) compatible floppy drive. Floppies should be double sided and formatted for DOS compatibility.
11	STOP	Red Push Button	To stop the measurement (terminate high voltage at the output terminals)
12	TEST		Indicate P/F Measurement Result based on preset limit
12a	FAIL	Red LED	When lit in <b>Resistance Mode</b> , the measured value is below the set minimum value (resistance limit). When lit in <b>Current Mode</b> , the measured value is above the set maximum value (current limit).
12b	PASS	Green LED	When lit, in <b>Resistance Mode</b> , the measured value is above the set minimum value (resistance limit). When lit in <b>Current Mode</b> , the measured value is below the set maximum value (current limit).
13	Caution High Voltage	Red LED	When lit, indicates presence of High Voltage at the output terminals.

### 1.3.2 Rear Panel Controls and Connectors

Figure 1-2 illustrates the controls and connectors on the rear panel of the 1865 Megohmmeter/IR Tester. Table 1-2 identifies them with description and function.

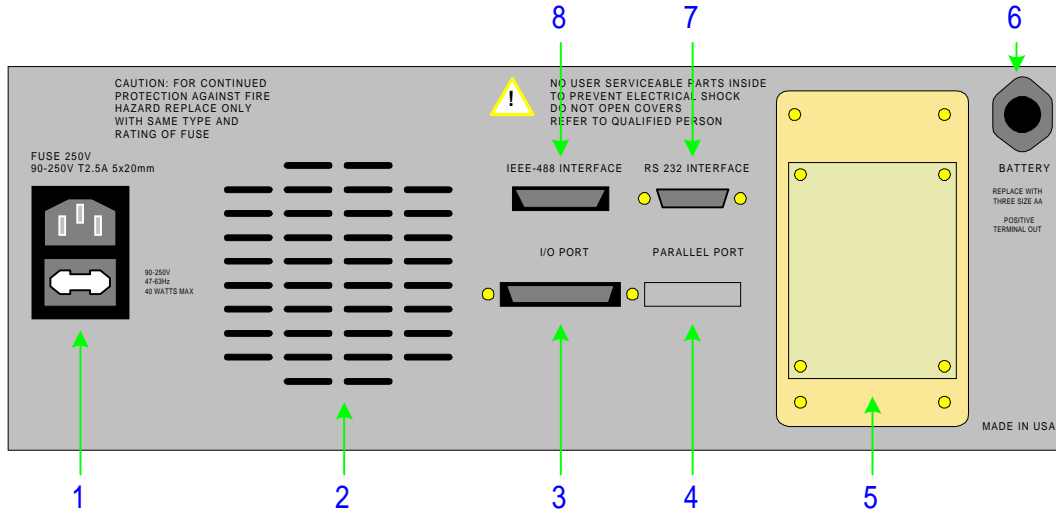

**Figure 1-2: Rear Panel Controls and Connectors**

**Table 1-2: Rear Panel Connectors and Controls**

Reference Number Figure 1-2	Name	Type	Function
1	AC Inlet Module	Black 3-Prong Receptacle & Fuse Drawer	3-wire connection for AC power source. 90-250V AC: T2.5A 250V 5x20mm Fuse
2	Vent	Rear Panel Portion	Instrument ventilation
3	I/O Port	36-pin Male Amp 552302-1 compatible	36-Pin Connector for Component Handler. Use with Amp 552302-1 plug & 552073-5 strain relief cover or ribbon cable clamp connector 553600-1 or equivalent(s).
4	Parallel Port	Not Available	Not Available
5	Option	1865-03	Rear Panel Input Terminals: Ground, (+), (-) and Guard for connection to DUT with High Voltage Indicator
6	Battery	3, AA Size Batteries	DC source for System Memory back-up. 3 AA batteries need to be replaced yearly.
7	RS232 Interface	9-pin DB9 Male	9-pin connector for RS232 I/O transfers
8	IEEE-488 Interface	24-pin Male	24-pin connector for IEEE-488 I/O transfers



## 1.4 Installation

### 1.4.1 Dimensions

The instrument is supplied in a bench configuration, i.e., in a cabinet with resilient feet for placement on a table. A bail is provided under the front edge so that the instrument can be tilted back for convenient operator viewing.

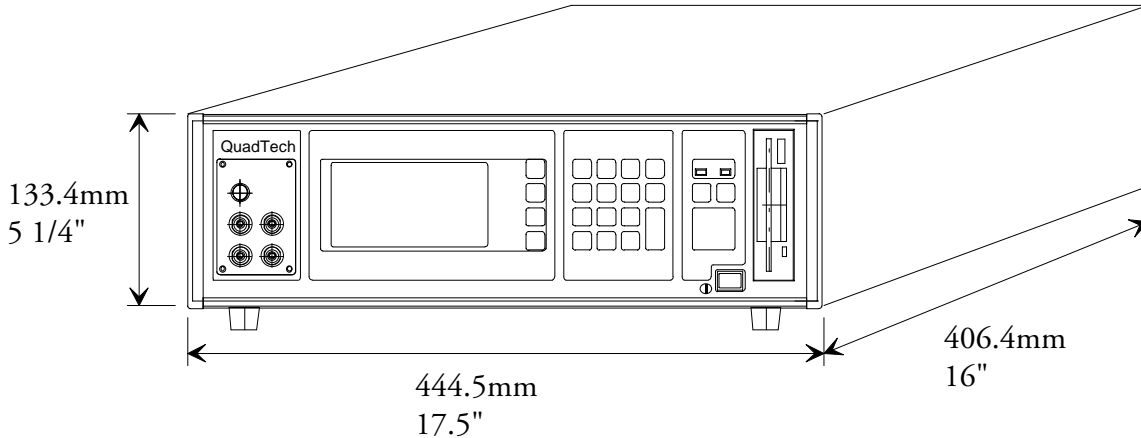



Figure 1-3: 1865 Instrument Dimensions

### 1.4.2 Instrument Positioning

The 1865 instrument contains a high resolution back lit LCD for convenient viewing. The optimum angle for viewing is slightly down and about 30° either side of center. This means that for bench operation the front bail should always be used to angle the instrument up and for rack installation it should be mounted at eye level or higher.

### 1.4.3 Power Requirements

 The 1865 Megohmmeter/IR Tester can be operated from a power source between 90 and 250Vac at a power line frequency of 47 to 63Hz. Power connection to the rear panel is through an AC inlet module comprised of an AC connector and fuse drawer. Before connecting the 3-wire power cord between the unit and AC power the fuse should be in accordance with the power source, T2.5A, 250V, 5x20mm (QuadTech PN 520049) for 115V or 220V source. Always use an outlet which has a properly connected protection ground. **The standard 1865 is factory shipped with the 2.5A fuse in place. The instrument can be damaged if the wrong fuse is installed.** To change the fuse proceed as follows:

## PROCEDURE FOR CHANGING A FUSE

### WARNING

**Make sure the unit has been disconnected from its AC power source for at least five minutes before proceeding.**

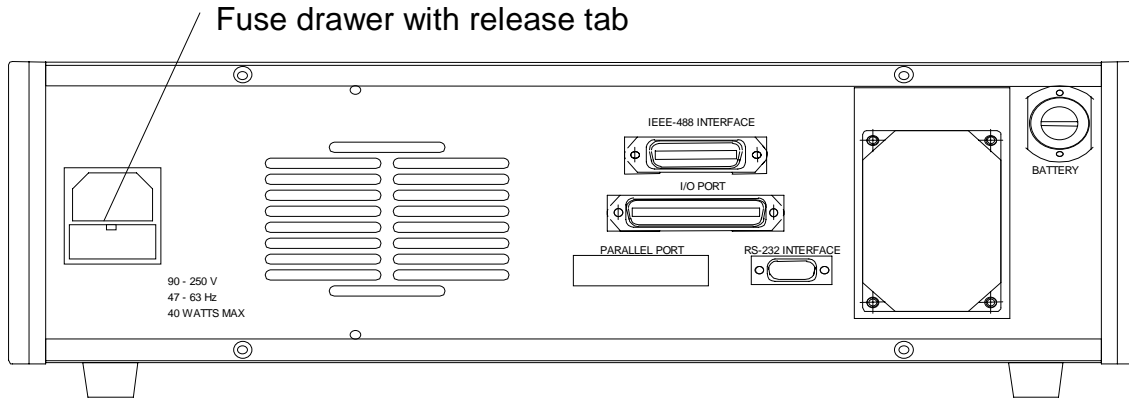

**Figure 1-4: 1865 Instrument Fuse Drawer**

- Remove the fuse drawer by inserting a small flat head screwdriver behind the small tab to force the draw outward.
- Once the fuse draw has been completely removed from the instrument now remove the clear fuse tray from the drawer by lifting upward slightly on the long narrow locking tab. This will allow the fuse tray to be removed from the fuse draw. This tray contains the active fuse (secured by holder).
- Remove the fuse from the holder by prying upward using a small flat head screwdriver. Insert the replacement fuse into the fuse holder.
- Once the fuse has been installed in the holder and spare fuse (if desired) installed in the right side of the tray insert the tray back into the fuse drawer, push in and lock. The two silver contacts on the fuse tray should be positioned towards the outside.
- Once the fuse tray has be installed in the draw, reinstall the fuse draw back into the instrument ac inlet module, push in and lock.

#### 1.4.4 Safety Inspection



Before operating the instrument inspect the AC power inlet module on the rear of the 1865 instrument to ensure that the **properly rated fuse is in place**, otherwise damage to unit is possible. Refer to paragraph 1.4.3.

The 1865 instrument is shipped with a standard U.S. power cord, QuadTech PN 4200-0300 (with Belden SPH-386 socket or equivalent, and 3 wire plug conforming to IEC 320) and CE units with an approved international cord set. Make sure the instrument is only used with these cables (or other approved international cord set) which ensures the instrument is provided with **connection to protective earth ground**.

When the 1865 instrument is used in a rack installation (using the QuadTech 1865-50 Rack Mount Kit) make sure the unit is **secured using the cabinet mounting rails** and not securely solely by the front panel angle brackets.

In bench or rack mount applications the instrument should be positioned with consideration for **ample air flow** to the rear panel fan ventilation holes. An open space of at least 3 inches (75mm) is recommend behind the rear panel. The surrounding environment should be **free from excessive dust** to prevent contamination of electronic circuits.

#### **WARNING**

**If this instrument is used in a manner not specified in this manual protection to the operator and equipment may be impaired.**

**Read this instruction manual in full before operating this instrument.**



---

## Section 2: Operation

---

### 2.1 Terms and Conventions

The names of keys in the manual will generally appear in CAPITAL LETTERS.

The MENU key calls up the main menu display and returns to the line previously selected.

The ">>" symbol on a menu indicates a lower level menu exists.

The select keys generally function as UP, DOWN, LEFT and RIGHT arrow and allow you to move through a menu or field of choices to make the desired selection or turn a function ON or OFF.

The ENTER key switches the unit to entry mode and when pressed again initiates the entry or choice selected on the current screen.

The CNCL key will return the system to main menu display with no changes made. (From a numeric data field CNCL must be hit twice).

### 2.2 Startup

Check to make sure the line voltage indicator on the rear panel AC inlet module agrees with the AC power source available, if not refer to paragraph 1.5.3.

Connect the instrument power cord to the source of proper voltage. **The instrument is to be used only with three wire grounded outlets.**

#### **WARNING**

A flashing **CAUTION HIGH VOLTAGE** light and/or **DANGER** on the display indicates a defective unit with dangerously high voltages possible at the input terminals. Power the unit down and do not use.

#### **IMPORTANT**

The interlock connector (included with the unit) needs to be installed on the rear panel I/O Port connector if the interlock function is **not** being used.  
When the 3.5" Floppy Drive Option is present **ALWAYS MAKE SURE NO DISKS ARE INSTALLED WHEN THE UNIT IS POWERED UP**, otherwise information stored on the disks could be lost.  
Switching [POWER] OFF and ON quickly may result in error messages. Power should be off for at least 10 seconds to assure proper power-up.

Power is applied to the 1865 by pressing the [POWER] button on the front panel. The instrument runs a self test and any error messages are displayed accordingly (refer to paragraph 2.8).

### 2.3 Zeroing

Before making measurements, the 1865 instrument should be zeroed to correct for test lead or fixture errors. During the zeroing process corrections are calculated and stored in instrument memory and applied to ongoing measurements. Generally the unit should be zeroed at least once per day and each time test leads or fixtures are changed. The zeroing routine is accessed through the Utilities Menu by selecting [ZERO], instructions are given on the LCD display. Refer to paragraph 2.6.4.3.

### 2.4 Connection to Device Under Test

Figure 2-1 illustrates the front panel input terminals and a basic block diagram of their function.

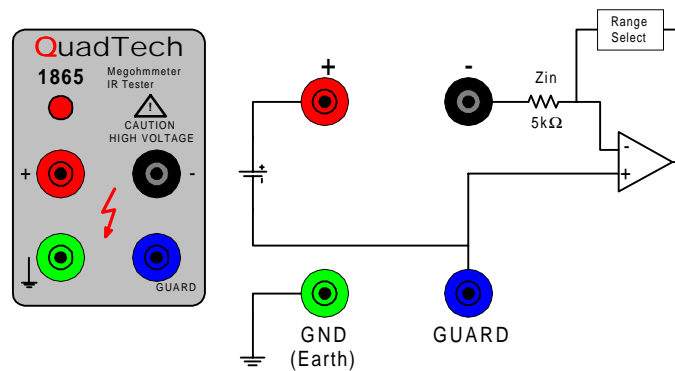
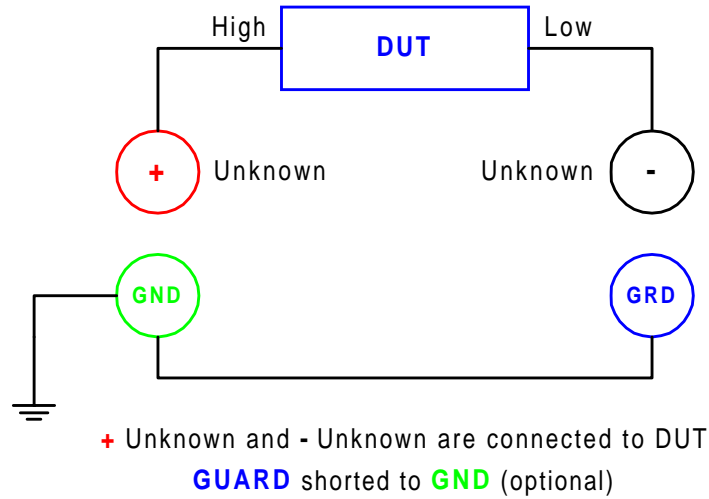

**Figure 2-1: Input Panel and Block Diagram**

An optional shielded lead set is available for use with the 1865 unit, QuadTech part number 1865-51. How the connection to the DUT is made depends on the device being measured: if it is a grounded, ungrounded or guarded device. The 1865 instrument is supplied with two resistor adapters which are recommended for use only when measuring high value, low leakage capacitors. These are to be added in series with the (-) terminal lead to eliminate fluctuating test results when measuring this type of device. Refer to paragraph 3.3.

**CAUTION**  
**DO NOT GROUND THE - (negative) UNKNOWN TERMINAL, invalid measurements will result.**

Figures 2-2 through 2-4 illustrate various methods of connection to the device under test (DUT). Figure 2-2 illustrates the two-wire connection to DUT. The two-wire ungrounded connection is the recommended connection of ungrounded components or components that can be connected very close to the 1865 input terminals rather than through the lead set provided.



**Figure 2-2: Two-Wire Ungrounded Connection**

The two-wire grounded measurement is a common type of connection to be used on the 1865. This is the recommended connection on grounded components or components that are some physical distance from the input terminals of the unit. A grounded component is one in which one of its connections goes to an earth ground, whereas on an ungrounded component neither connection goes to earth ground. A component being measured with a lead set is considered to be a physical distance away from the terminals and thus the two-wire grounded connection is often recommended.

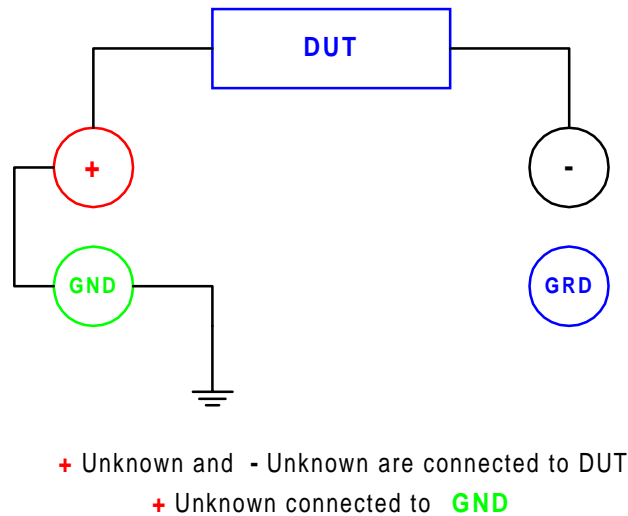

**Figure 2-3: Two-Wire Grounded Connection**

A three-wire guarded connection is necessary to measure resistance between two points in the presence of resistance from each of these points to a third point. Refer to paragraph 3.6 for a discussion of guarded measurements. The guarded measurement may require different grounding techniques depending on the expected impedance of the DUT.

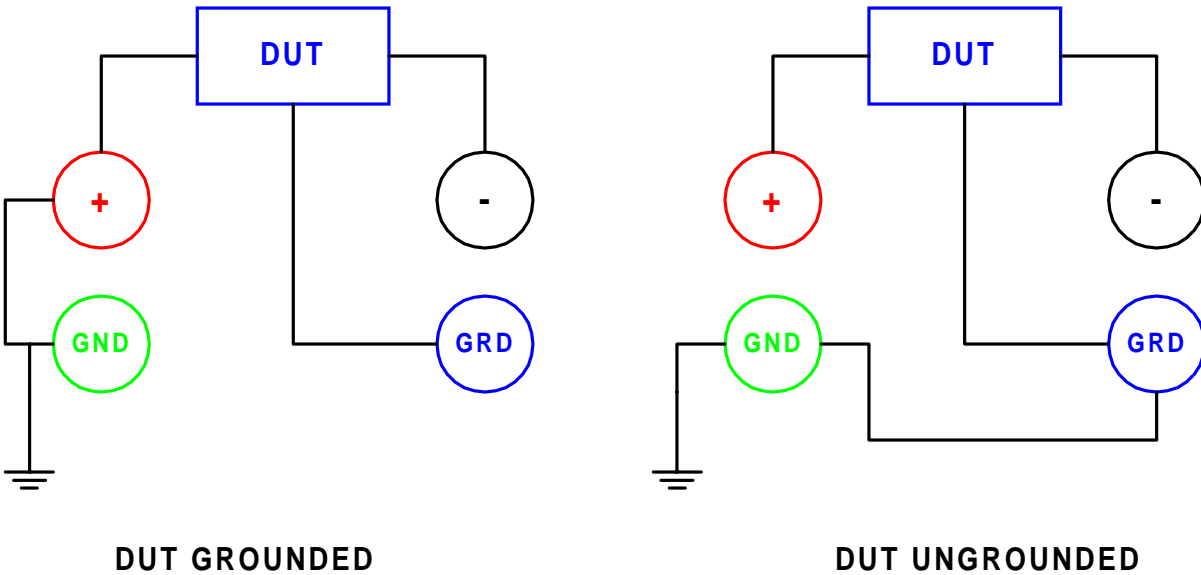

+ Unknown and - Unknown are connected to DUT

**GUARD** to DUT Guard Point

+ Unknown shorted to **GND**

OR

**GUARD** shorted to **GND**

**Figure 2-4: Three-Wire Guarded Connection (Grounded or Ungrounded)**

## 2.5 Measurement Procedure

### 2.5.1 General

There are two basic measurement modes of operation, auto and manual. In the automatic mode the test cycle is sequenced automatically through four phases, charge, dwell, measure and discharge in accordance with user programmable times. This is the preferred measurement mode, especially when the approximate resistance value is unknown, since the 1865 instrument employs an auto ranging technique. The automatic mode would generally be used in a production environment where measurements are repetitive and setup conditions have been previously established. For the sake of reducing measurement time, when making repetitive measurements, a particular range may be locked in, in place of auto ranging.



In the manual mode the test cycle timing is totally at the users discretion where each of the three phases, charge, measure or discharge is initiated directly by the user. This mode would typically be used in an engineering environment or component evaluation where the measurement results can be observed as test cycle and measurement conditions are altered.

Whenever the 1865 unit is powered up it is ready to begin measuring at default test conditions. Initially, these conditions will be set to a factory default (1V, 0 times, Resistance Display, Auto ranging and Automatic Mode), but can be changed by the user and stored to overwrite factory default.

### **2.5.2 Default Measurement Conditions**

A set of default measurement conditions are initially established at the factory and stored in instrument memory. Default conditions are those that determine the instruments status on power up, thus the instrument is always set to a known state before any testing begins. These conditions can be changed by the user for tailoring to a specific application. Refer to paragraph 2.6.4.1 under Save Setup on the Utilities menu.

Factory default measurement conditions are:

#### Under Setup Menu

Voltage - 1V  
Charge, Dwell, Measure and Discharge times – 0  
Mode - Auto  
Range - Auto (Selected on lower level menu)  
Limit - None  
Stop on Pass - No  
# to Average - None

#### Under I/O Menu

Display Type - Resistance (selected on lower level menu)  
Result Format - Engineering Units  
RS-232 - Enable  
Handler - On

#### Under Utilities Menu

Lockout - Off  
Backlite - On

### 2.5.3 Automatic Measurement Mode

Measurements in the automatic mode can be initiated after connecting the DUT by simply pressing [START]. Test conditions are determined by either the power up default conditions or recalling a previously stored setup from instrument memory. In either case a test cycle is sequenced automatically (Figure 2-5) once [START] is pressed and results displayed (Figure 2-6). When a test limit is entered a PASS/FAIL can be displayed in place of the actual measured value (Figure 2-7).

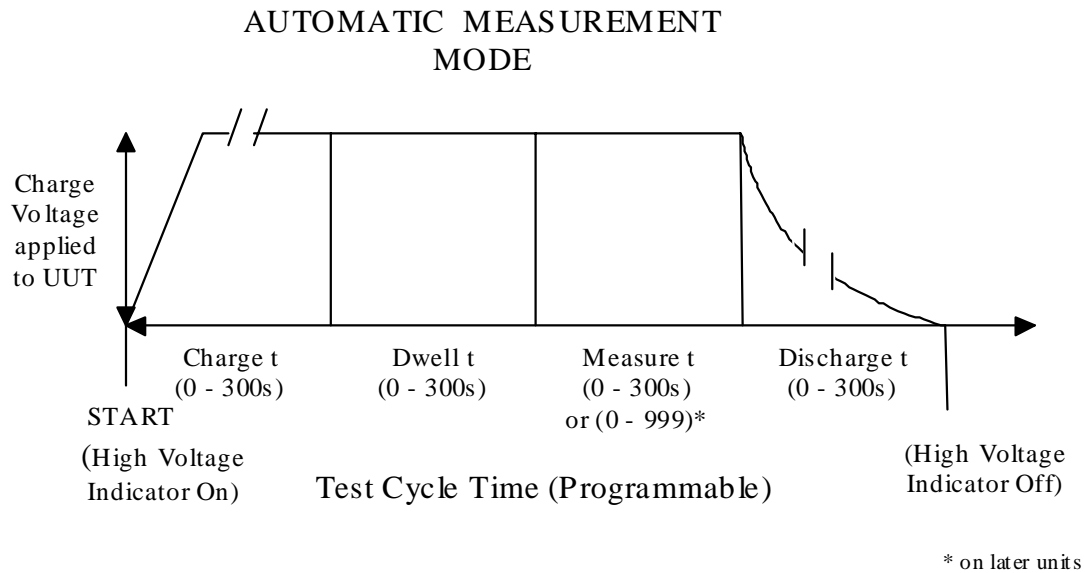

**Figure 2-5: Test Cycle Sequence (Automatic)**

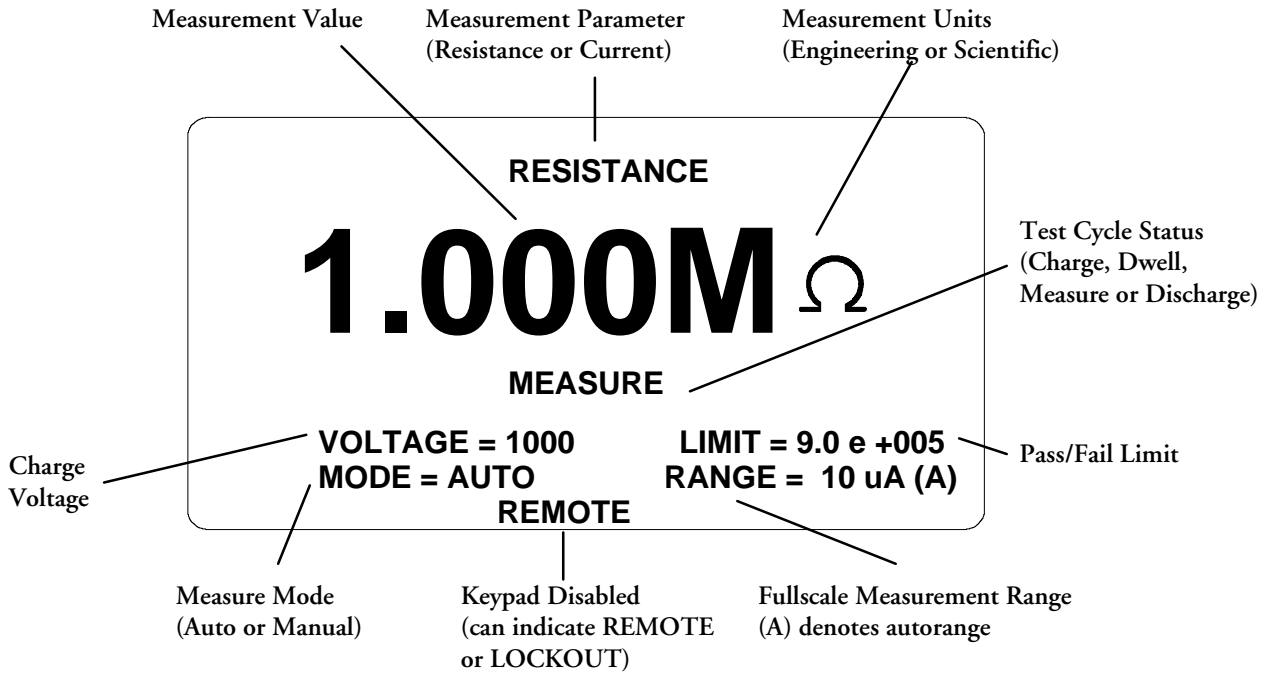

**Figure 2-6: Measurement Results Display with Value**

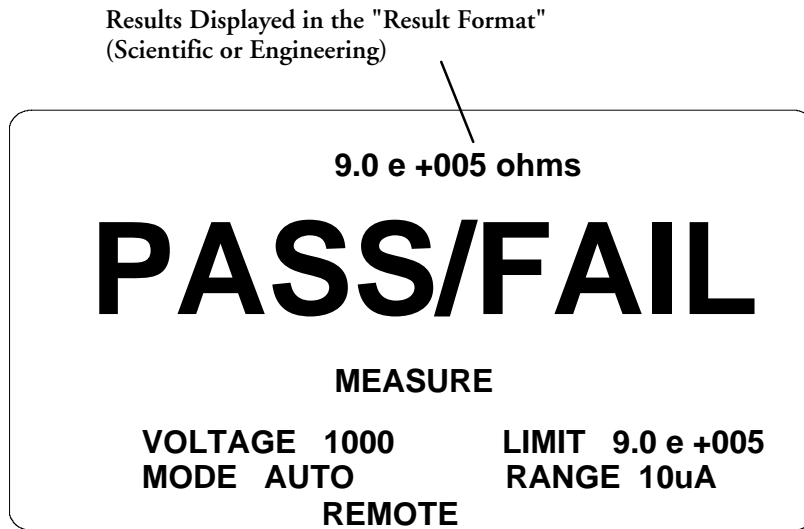

**Figure 2-7: PASS/FAIL Results Display**

## 2.5.4 Manual Measurement Mode

The primary difference between automatic and manual mode is that in manual mode the phases of the test cycle must be initiated manually by the user. Here there are three phases rather than the four in automatic, the dwell function would be part of the charge phase. The results would still be displayed in a manner indicated above, the mode would indicate manual rather than automatic. Default and other stored setups can still be recalled, the only difference being that the test cycle times are not applicable.

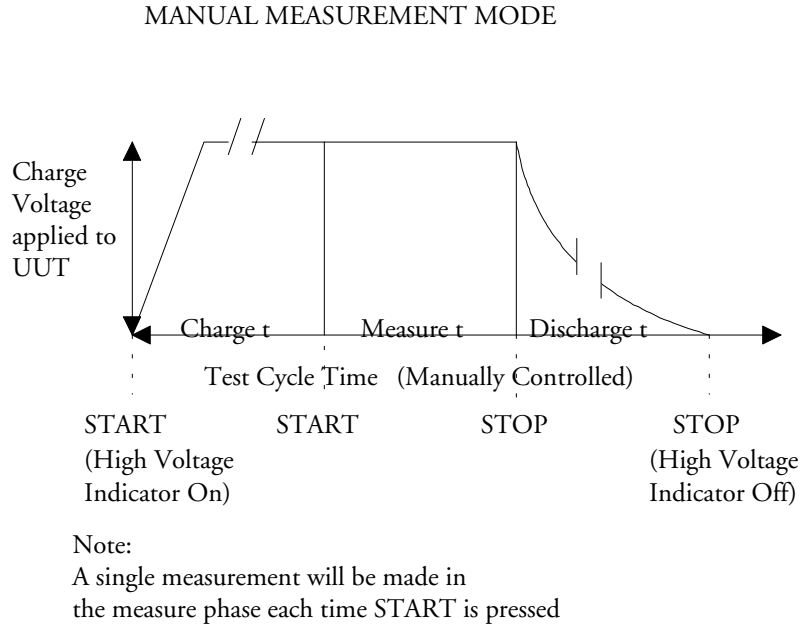

**Figure 2-8: Test Cycle Sequence (Manual)**

## 2.6 Menu Functions

### 2.6.1 General

All programmable functions of the 1865 are controlled by easy to use menu displays. The user enters the menu mode by selecting the [MENU] key which calls up three top level menus, Setup, I/O and Utilities. Each one of these is comprised of a sub menu list whose functions are described in detail below. Finding ones way around the menu listing is accomplished in a fashion similar to an Automatic Teller Machine (ATM) using the up, down, right and left arrow keys as indicated on the adjacent LCD display. A highlighted menu function can be controlled by selecting the [ENTER] key, making the desired entry or selection and pressing [ENTER] again to implement.

## 2.6.2 Setup Menus

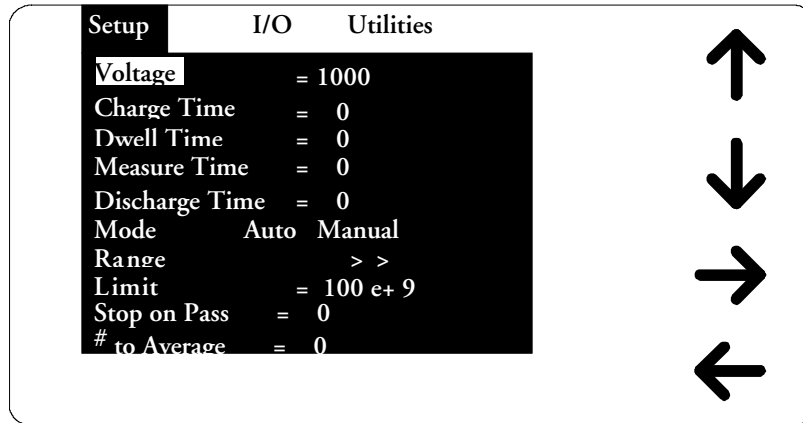

**Figure 2-9: Setup Menu**

The first of the three main menus is Setup, shown in Figure 2-9. Each function controls a measurement condition and is described in detail below.

### 2.6.2.1 Voltage

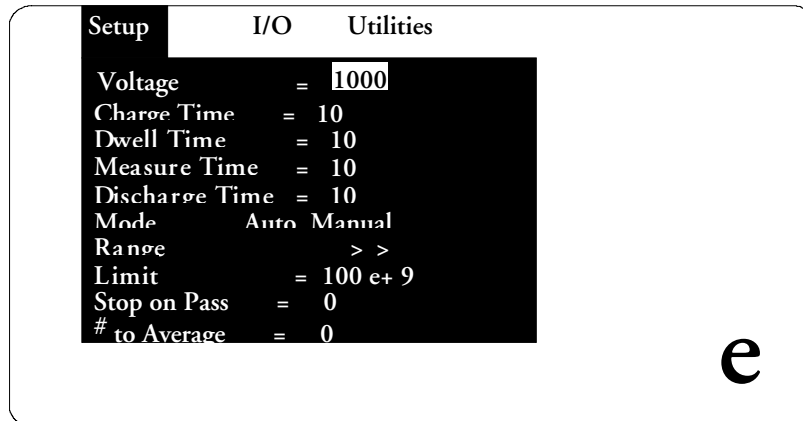

**Figure 2-10: Test Voltage Entry**

 Accepts entry (up to 6 digits and decimal) of a test voltage between 1 and 1000 volts. This is the voltage applied to the unit under test during the test cycle and present at the DUT connection anytime that the CAUTION HIGH VOLTAGE lamp is ON. As in the case of many of the menu entries on the 1865 instrument, an "error message" will be displayed for an invalid entry.

### 2.6.2.2 Charge Time

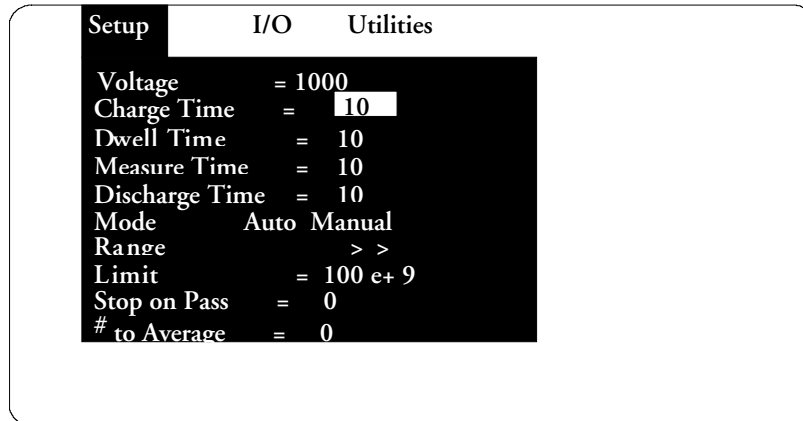

**Figure 2-11: Charge Time Entry**

Accepts entry of a charge time between 0 and 300 seconds in 1 second intervals (up to 3 digits). If the selection is out of range an error message will be displayed. This marks the time when the test voltage is first applied and the unit under test is allowed to charge up to this voltage. Even if the charge time is entered as zero there is still a small delay during the charge phase. In this case or even with much longer charge times the possibility exists that full charge voltage may not be reached at the start of the measurement phase if the DUT has a long time constant.

**NOTE**

For low voltage measurements (<5V), a minimum charge time of 2 seconds is recommended to meet the instruments stated accuracy.

### 2.6.2.3 Dwell Time

Accepts entry of a dwell time (or electrification time) between 0 and 300 seconds in 1 second intervals. This is a time during which the test voltage is applied to the device under test and prior to any measurement.

### 2.6.2.4 Measure Time

Accepts entry of a measure time between 0 and 300 seconds in 1 second intervals (0 – 999 seconds on later units). This is the time during which repeated measurements are made and results displayed as resistance, current, Pass/Fail or no display depending on the results format selected. The display is updated each time a measurement is made during this time phase.

### 2.6.2.5 Discharge Time

Accepts entry of a discharge time between 0 and 300 seconds in 1 second intervals. This is the time when the test voltage is removed and the device under test discharged. The CAUTION HIGH VOLTAGE lamp goes OFF at the end of the programmed interval and the last measurement result is retained on the display (unless no display is selected).

### 2.6.2.6 Mode

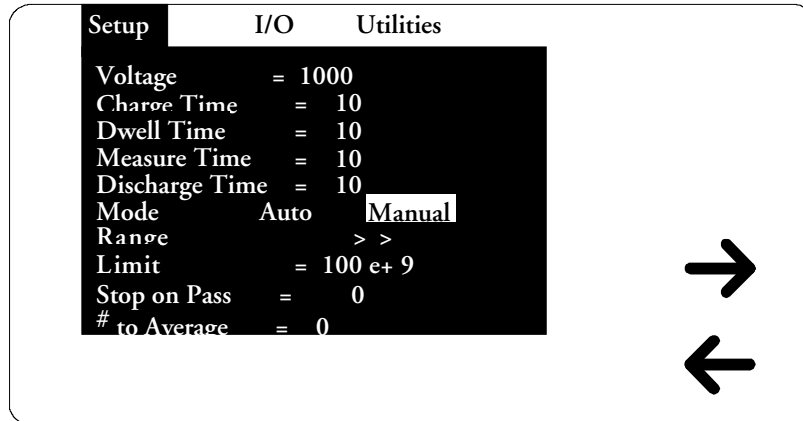

**Figure 2-12: Measurement Mode Selection**

Allows selection from two different modes of operation, **Auto** or **Manual** measurement.

In Auto the user presses [START] to initiate the entire test cycle automatically. The first phase of the cycle is charge time, during which the device initially charges up to the applied test voltage. The second phase is dwell, or time of electrification, during which the device is fully charged but prior to a measurement. The third phase is measure time during which measured results are displayed. The fourth and last phase is discharge time during which the voltage is removed and the device allowed to discharge.

In Manual, test cycle timing is under complete user control, [START] must be pressed to initiate the charge and measure phase and [STOP] pressed to discharge the device.

### 2.6.2.7 Range

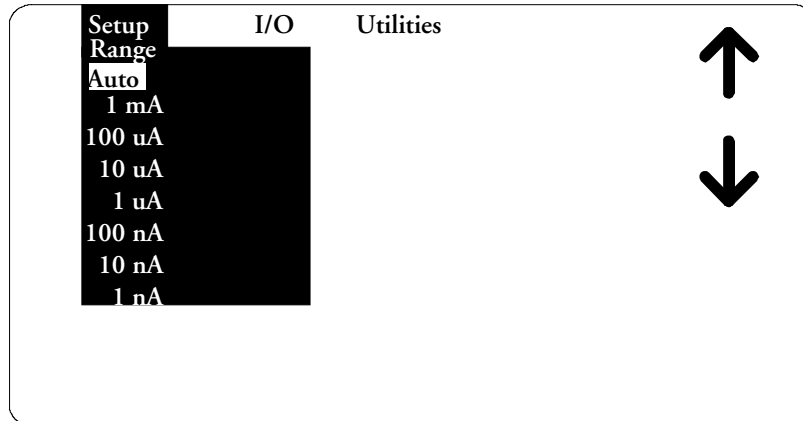

**Figure 2-13: Range Selection**

Through a lower level menu (by pressing [ENTER]) allows for selection of **Auto** or one of seven different measurement ranges (**1mA through 1nA**), which is the maximum current for the selected range. In auto mode the 1865 instrument will automatically select the optimum range depending on the programmed test voltage and current drawn by the test device. Any choice other than Auto (1mA through 1nA range) is at the user's discretion. Determination of the range is governed by the maximum current available to the DUT for that measurement range and is listed in Table 2-1. **To eliminate operator errors in range setting and ensure specified instrument accuracy the 1865 unit should generally be left in AUTO.** There may be an exception to this when repetitive measurements are to be made on a known range and there is a desire to reduce test time by eliminating range switching. When auto ranging is selected the 1865 instrument will always begin the measurement phase on the highest current range, 1mA and progress down depending on the current to the device under test. If the current reaches 10% or less of the maximum for a given range the next lowest range will be switched in.

If a range has been selected and the current exceeds 115% of the maximum for that range the unit will indicate OVER RANGE on the display. One needs to keep in mind that an over range does not necessarily mean the incorrect range has been selected, the device under test could also be defective. Over range should not be confused with an OVERLOAD display. Overload occurs anytime current to a device attempts to exceed 2mA, this would generally mean a shorted or very low resistance device.



**Table 2-1: Range Current**

<b>Range</b>	<b>Maximum Current</b>
1	1mA
2	100uA
3	10uA
4	1uA
5	100nA
6	10nA
7	1nA

**Example:**

When measuring an unknown of  $200\text{M}\Omega$  at  $100\text{V}$ , Ohms Law tells us that the device under test would draw  $0.5\text{uA}$  ( $I = 100\text{V}/200\text{M}\Omega$ ). Based on the above one would expect the 1865 instrument to auto range from the  $1\text{mA}$  to  $1\text{uA}$  range (50% of maximum current) or the user to select the  $1\text{uA}$  range if prior knowledge of the expected results is known.

**NOTE**

When measuring in the current mode, in order to calculate the unknown resistance, the input resistance of the instrument ( $5\text{k}\Omega$ ) must be taken into consideration. For further discussion of this refer to Display Type in ¶ 2.6.3.1

The measurement range capability is represented graphically in Figure 2-14. By locating the charge voltage on the vertical axis and the measured resistance, or expected measured resistance, on the horizontal axis one can determine the optimum range. When Auto range is selected the range switching is done automatically and the specified instrument accuracy always applies. If a range is selected other than auto and the resistance value for the given voltage does not fall in the range band shown measurement accuracy as specified does not necessarily apply.

### Measurement Ranges at Specified Voltage

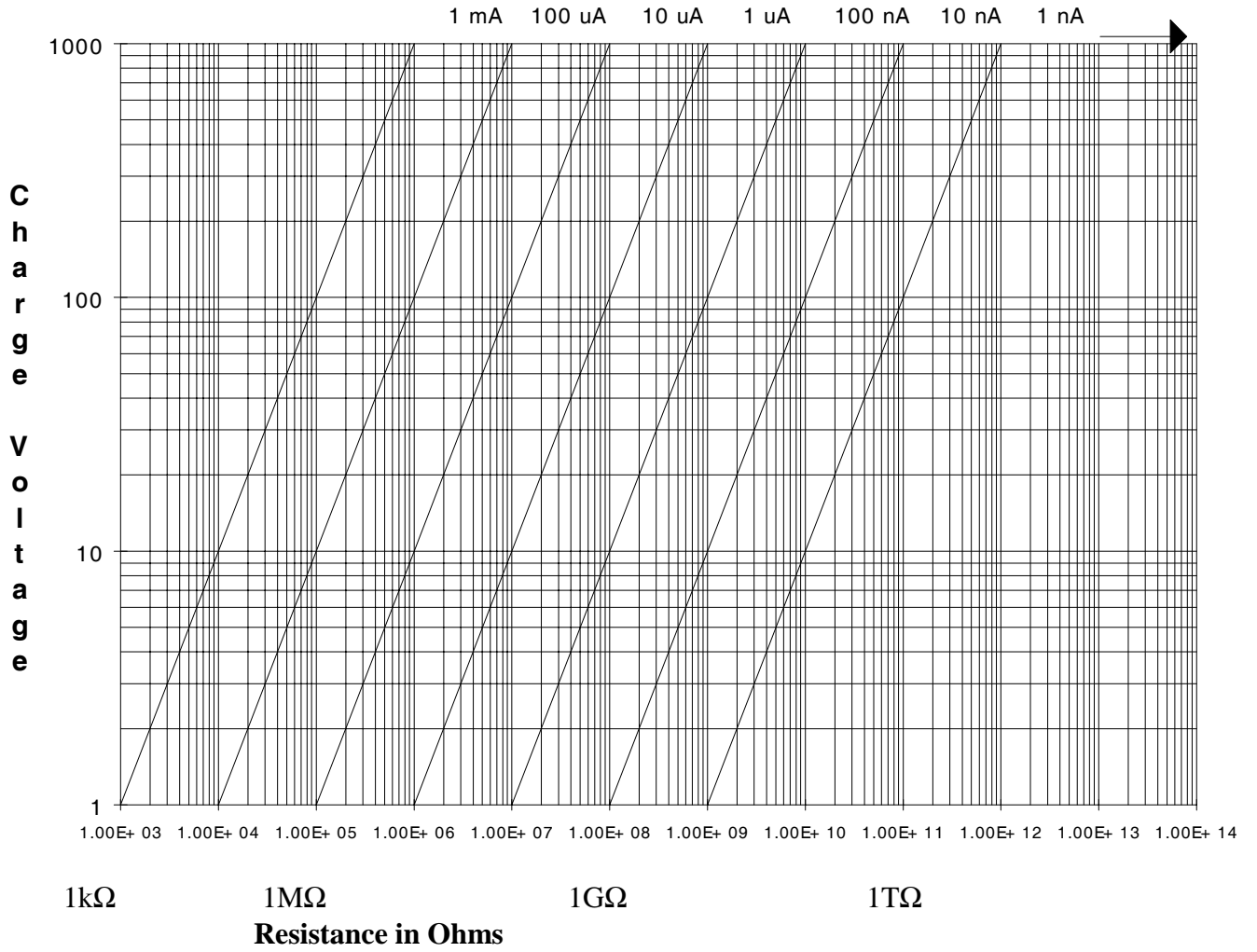

**Figure 2-14: Measurement Range Capability**

### 2.6.2.8 Limit

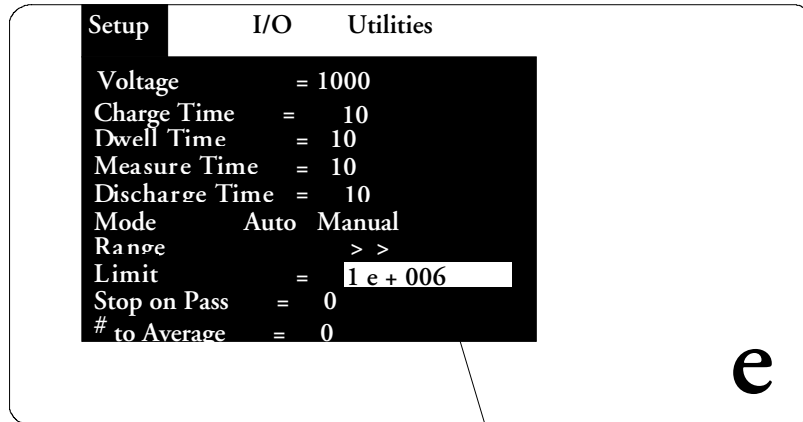

In the case where I (current) is selected rather than R (resistance), the exponent would be entered as a negative number.

**Figure 2-15: Limit Value (Resistance or Current)**

Allows entry of a single measurement limit in scientific units (up to 4 digits with decimal and exponent) for resistance or current depending on the results parameter selected. The exponent must be 3 through 14 for resistance or -3 through -13 for current. This limit determines the status of the Pass/Fail indicator and Pass/Fail display, when enabled. When the 1865 instrument is in the resistance mode the limit is a minimum value i.e. any value above the limit will result in a Pass, whereas a value below the limit will result in a Fail. The opposite is true when the unit is in the current mode, the limit is a maximum value, any value below the limit will result in a Pass and a value above the limit will result in a Fail.

If the display parameter on the I/O Menu is selected as resistance the value entered will be an R limit, if the display is selected as current the value entered will be an I limit. The 1865's processor will check for consistency between the parameter display selected and limit entered.

An example of the sequence for entering 1M $\Omega$  as a limit would be:

Press [ENTER]	or	Press [ENTER]
Press [1]		Press [1]
Press [e] select key		Press [0] (zero), three times
Press [6](exponent multiplier)		Press [e] select key
Press [ENTER]		Press [3]
		Press [ENTER]

### **2.6.2.9 Stop on Pass**

Accepts entry of a value between 0 and 300 which is the number of consecutive passing measurements that must occur to exit the measure loop before the measure time has passed. This is only active when there is a measure time and limit specified. An entry of 0 disables the stop on pass function.

### **2.6.2.10 # to Average**

Accepts entry of a value between 0 and 400 which is the number of measurements to be averaged and displayed. If the value is 0 or 1 averaging is disabled and the display is updated with each measurement, if the value is n (between 2 and 400) the average is displayed after n measurements. If the measure time has not elapsed after the first averaged display then a running average of measurements is made until the measure time is up. For example, if n is 5, the first five measurements are made, averaged and then displayed. The sixth measurement is averaged with the last four and the first ignored, this continues until the user specified measurement time is complete.

When Stop on Pass is in effect n measurements are made and averaged.

If the Stop on Pass requirement is met the cycle stops with a Pass even though the measure time has not passed.

If the measure time has passed and the Stop on Pass requirement not met the cycle stops with a Fail.

If the Stop on Pass requirement is not met and measure time has not passed additional measurements are made and averaged. The Stop on Pass and measure time requirement are tested after each measurement until one or the other results in an exit from the test cycle.

When the instrument is selected for Manual mode of operation the averaging works very similar. When the [START] button is pressed to exit charge and start measure, n measurements are averaged. For each consecutive press of the [START] button one more measurement is made, the last five averaged and result displayed. The [STOP] button exits measure to discharge as normal.

### 2.6.3 I/O Menus

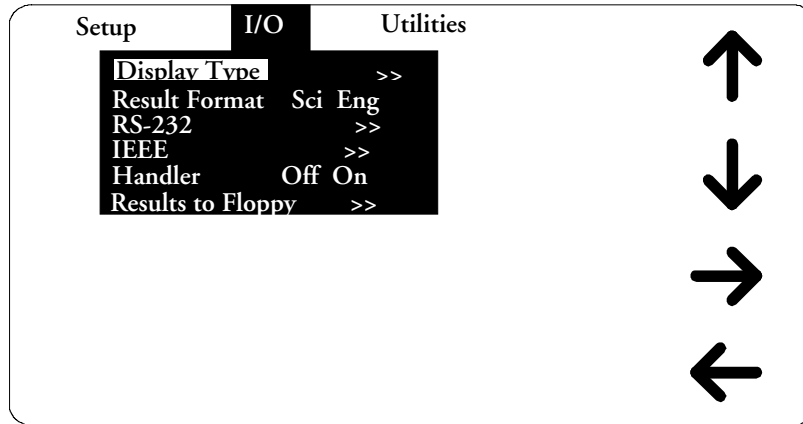

**Figure 2-16: I/O Menu**

The second of the three main menus is I/O, shown in Figure 2-16. Each function controls measurement results or instrument I/O interface and is described in detail in paragraphs 2.6.3.1 through 2.6.3.6.

#### 2.6.3.1 Display Type

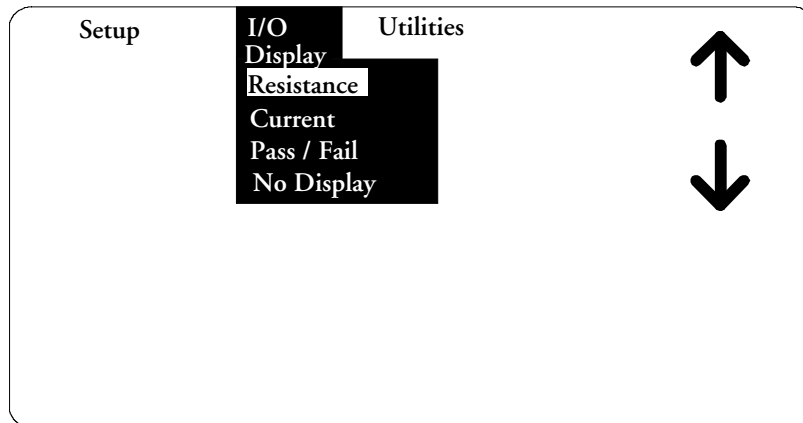

**Figure 2-17: Measurement Display**

Allows selection from four different modes of measurement display, **Resistance**, **Current**, **Pass/Fail** or **No Display**. In resistance mode the 1865 instrument will display the measured value of resistance of the device under test. In current mode the 1865 displays the current to the device under test. In Pass/Fail mode the actual measured value is displayed in small font along with a pass or fail based on the measurement limit entered, which could apply to either resistance or current.

In No Display only the voltage, mode and range are displayed, with no measured value. This might be used for security reasons or for the purpose of reducing test time during remote operation.

When the display is selected as current one needs to keep in mind that the 5kΩ input impedance and the 1kΩ output voltage source impedance of the unit are in series with the unknown. For low values of resistance (<20MΩ) the measured current would be the Charge Voltage/(Z<sub>in</sub> + Z<sub>out</sub>+ R<sub>unknown</sub>).

### 2.6.3.2 Result Format

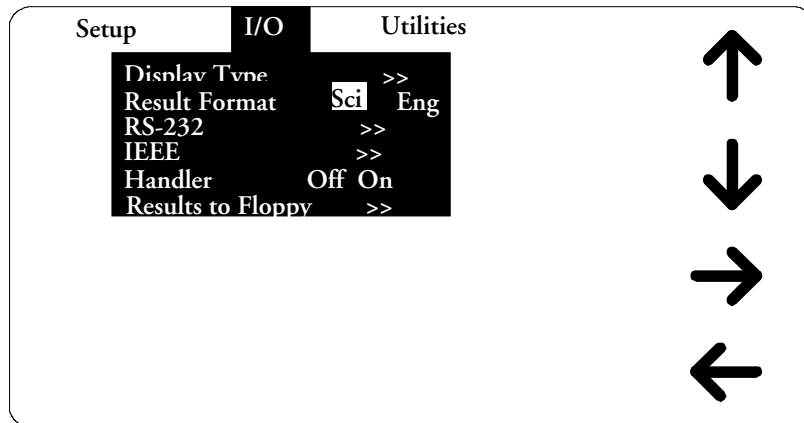

**Figure 2-18: Measurement Results Format**

Allows selection from two different measurement result formats **SCI** and **ENG**, for scientific or engineering units. Scientific units are expressed as an exponent and engineering units are expressed in ohms for resistance and amps for current. For example e<sup>6</sup> in scientific units can be expressed as MΩ in engineering units or e<sup>-6</sup> in scientific units can be expressed as μA in engineering units, this is strictly user preference and convenience.

When scientific units is selected the results will always be displayed as 5 digits and an exponent. The 5 digits will be configured as 1 to the left and 4 to the right of the decimal point. When engineering units is selected the results will be displayed with a minimum of 4 and maximum of 6 digits, there is always 3 to the right of the decimal point but to the left there could be 1, 2, or 3 digits depending on value. For example; when the units is MΩ and depending on the device being measured the display might show 1.123MΩ, 10.123MΩ or even 100.123MΩ.

A summary of measurement units (scientific and engineering) and their symbols is given in Table 2-2.

**Table 2-2: Measurement Unit Prefixes**

<u>Multiple</u>	<u>Scientific</u>	<u>Engineering</u>	<u>Symbol</u>
1000000000000000	$10^{15}$	Peta	P
1000000000000	$10^{12}$	Tera	T
1000000000	$10^9$	Giga	G
1000000	$10^6$	Mega	M
1000	$10^3$	Kilo	k
.001	$10^{-3}$	milli	m
.000001	$10^{-6}$	micro	$\mu$
.000000001	$10^{-9}$	nano	n
.000000000001	$10^{-12}$	pico	p
.000000000000001	$10^{-15}$	femto	f

**2.6.3.3 RS-232**

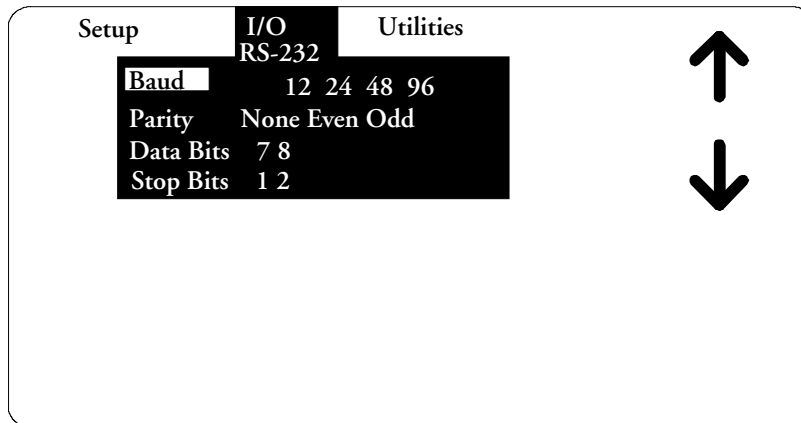

**Figure 2-19: RS-232 Interface Setup**

Allows user setup of standard RS-232 interface formats. Selections include:

- Baud Rate: 12, 24, 48 or 96
- Parity: None, Even or Odd
- Data Bits: 7 or 8
- Stop Bits: 1 or 2

When using the RS-232 interface with a printer the IEEE-488 Mode must be set to **Talk** and the State to **Disable**.

### 2.6.3.4 IEEE-488

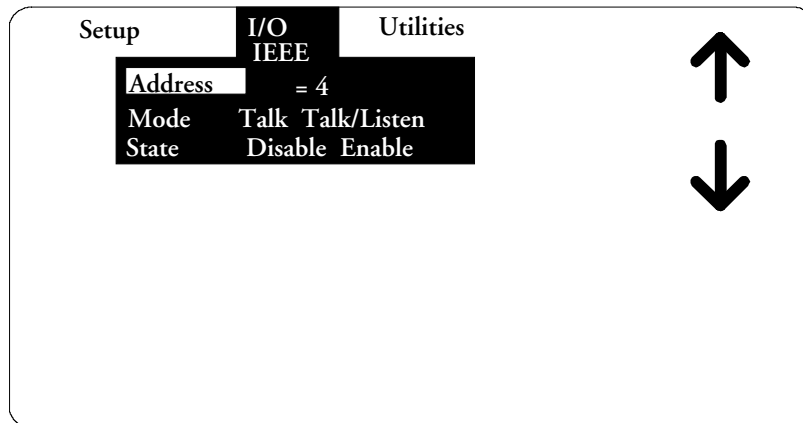

**Figure 2-20: IEEE-488 Interface Setup**

Allows user setup of IEEE-488 interface operation. Selections include:

- Address: 1 through 16
- Mode: Talk or Talk/Listen
- State: Disable or Enable

The instrument will function as either a Talk or a Talk/Listen device in a system depending on the choice made by the operator under Mode. Talk is generally suited to a simple system with no controller or other talkers, for example a printer. Talk/Listen denotes full programmability and is suited for use in a system that has a controller or computer to manage data flow. The "handshake" routine assures that the active talker proceeds slowly enough for the slowest listener.

### 2.6.3.5 Handler

Allows user to turn Handler Interface function **On** or **Off**. When off is selected, input and output lines on the rear panel I/O interface connector are ignored

### 2.6.3.6 Results to Floppy

Allows user to store measurement results on floppy disk (if optional drive is present). When selected, if a results file is not open, the user is prompted for the filename (up to 8 characters) and the file is opened.

To close a results file that is currently open, select Results to Floppy and press [ENTER] to close. Display indicates "Closing the Results File".

If a results file is open when a setup is saved, when the setup is later recalled the user will be prompted for a results file name.



When multiple tests are being conducted the results are stored to floppy periodically (every 10 measurements) from an internal buffer. **To be sure of storing all results before power is shut down the file needs to be closed** as discussed earlier. It is also important to note that a file should be closed before changing or recalling a new set of test conditions, otherwise the stored measurement results would not be consistent with the setup conditions stored in the file.

**NOTE**

3 1/2" floppy disks must be formatted for DOS compatibility on a PC or purchased formatted from the manufacturer, 1.44M high density or 720K low density.  
 Turning the instrument on with a floppy disk in the drive may cause a loss of data.

The measurement results (one for each complete measurement cycle) are stored as a DOS text file under its assigned identifying number (up to 8 characters) with an extension of .65R. The test setup conditions are saved as a header at the beginning of a results file. A sample file format is shown below. Notice that the results can be stored in either engineering or scientific terms dependent on what the user has selected for setup conditions.

```

100.000000      ;voltage
0.000000       ;charge time
0.000000       ;dwell time
0.000000       ;measure time
0.000000       ;discharge time
0.000000       ;mode (0 = auto, 1 = manual)
0.000000       ;range
1000000.000000 ;limit
0.000000       ;stop on pass
1              ;# to average
0.000000       ;display type
.000000        ;result format
3.000000       ;baud rate (0 = 1200, 1 = 2400, 2 = 4800, 3 = 9600)
0.000000       ;parity
1.000000       ;data bits
0.000000       ;stop bits
4.000000       ;IEEE address
1.000000       ;IEEE mode
0.000000       ;IEEE state
1.000000       ;handler
0.000000       ;result to floppy
1.000000       ;backlite (0 = off, 1 = on)
ENDHEADER
  
```

1.020 M ohmPASS  
 1.020 M ohmPASS  
 1.020 M ohmPASS  
 1.020 M ohmPASS  
 1.020 M ohmPASS  
 1.020 M ohmPASS

or

1.020015E+006 PASS  
 1.020015E+006 PASS  
 1.020015E+006 PASS  
 1.020015E+006 PASS  
 1.020015E+006 PASS

The number of measurement results that can be stored is dependent on available disk space and length of the data string. For example; if no limit is set the measurement string contains no pass/fail result, thus the string is fewer characters. The same is true with header information, multiple headers (different test conditions) will consume more memory. Whatever the case, a blank disk is capable of storing thousands of measurements.

#### 2.6.4 Utilities Menus

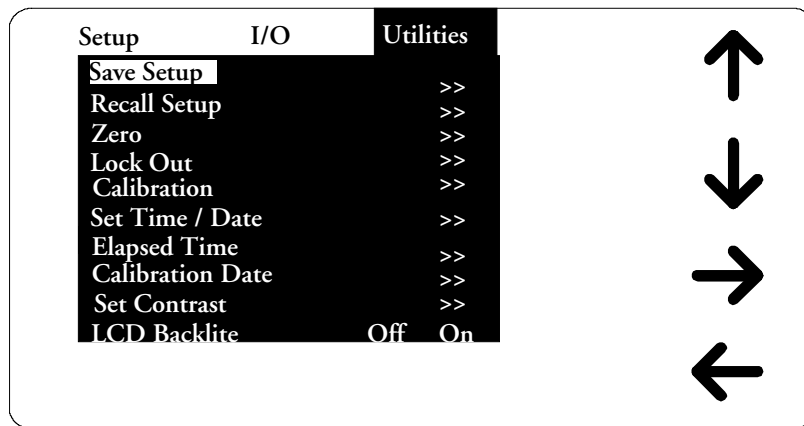

**Figure 2-21: Utilities Menu**

The last of the three main menus is Utilities, shown in Figure 2-21. Each function is described in detail in paragraphs 2.6.4.1 through 2.6.4.10.

### 2.6.4.1 Save Setup

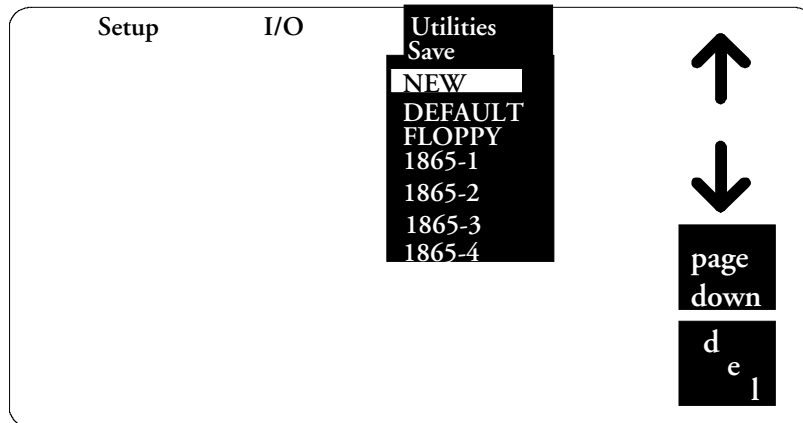

**Figure 2-22: Save Setup Test Conditions**

Allows a set of test conditions to be stored in instrument memory or on floppy disk (if optional drive is installed) for later recall. Test conditions are those that are user programmable in the Setup and I/O menus, refer to paragraphs 2.6.2 and 2.6.3 above.

**Stored setup conditions should always be backed up on disk when the floppy drive option is present or recorded on paper when this option is not present.**

**NOTE**

Setup conditions stored internally or on floppy disk using earlier software are not compatible with version 2.0 or later.

To store the current set of test conditions as a new set in unit memory one needs to select [NEW] in the Save Setup menu and enter the identifying name up to 8 characters under which these conditions will be stored (allowable characters from the keypad include 0 through 9 and minus, characters can also include A through Z when operating from remote control ). To save the setup under the name selected or to overwrite if the name already exists one needs to answer Yes or No, Figure 2-23.

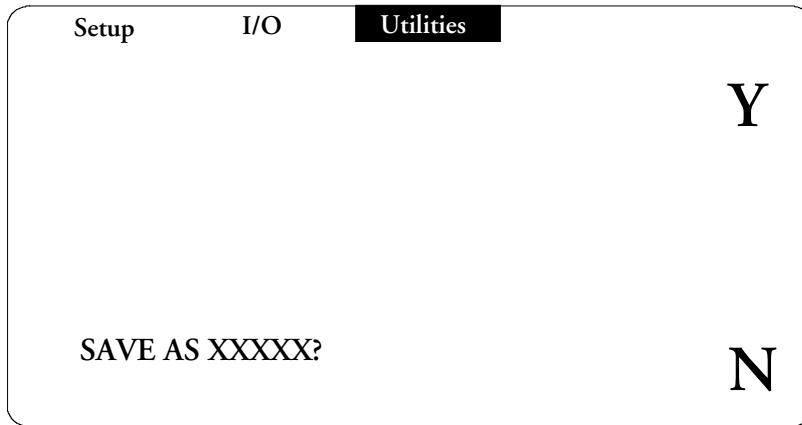

**Figure 2-23: Save/Overwriting Setup**

To make the current set of test conditions the default (at power up) one needs to select **[DEFAULT]** in the Save Setup menu and overwrite the conditions currently stored. To prevent overwriting the default setup by mistake an additional level of safety exists where the operator is required to respond with Yes or No, similar to Figure 2-23.

Selecting **[del]** will delete a set of test conditions and requires a Yes or No response.

When there are more setups than can fit on the display the page down key is active. If there is less than a whole page below, the display wraps around to the previous display. Continuing to page down will eventually return to the first display of setups. The page down key is only shown when there are more setups than what is visible.

There are two ways to make the current set of test conditions overwrite an existing setup, one is to select that setup in the menu and answer Yes to overwrite and the other way is to enter the same name under New and answer Yes to overwrite.

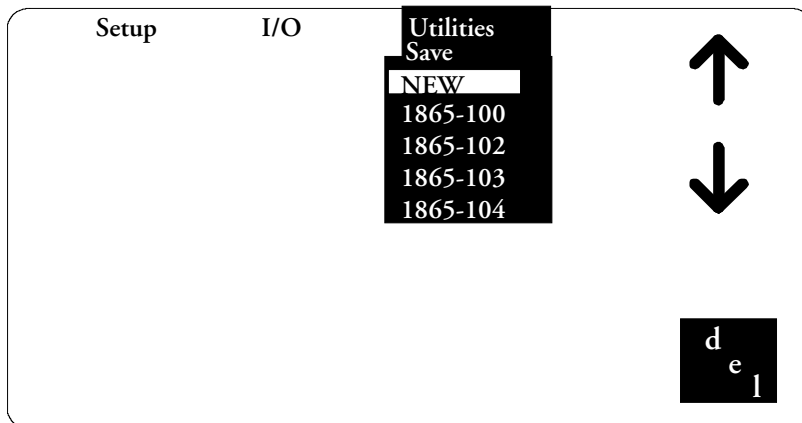

**Figure 2-24: Saving Setups on Floppy**

It is possible to store about 25 sets of test conditions in unit memory and many more can be stored on 3 1/2" disks when the 1865 includes the floppy drive option.

**NOTE**

3 1/2" floppy disks must be formatted for DOS compatibility on a PC or purchased formatted from the manufacturer, 1.44M high density or 720K low density. Setups are saved in DOS format, refer to paragraph 2.6.3.6.

Turning the instrument on with a floppy disk in the drive may cause a loss of data.

With this option, to save a set of test conditions on disk one needs to select [FLOPPY]. From the menu in Figure 2-24, one can save a new setup or overwrite an existing one on the disk in a manner previously described in internal instrument memory. Pressing [CNCL] reverts the menu back to those stored in internal memory, Figure 2-22.

The number of setups saved to floppy must be **limited to no more than 40**. Saving more than 40 setups can result in memory overwriting, false error messages or instrument lockup.

**2.6.4.2 Recall Setup**

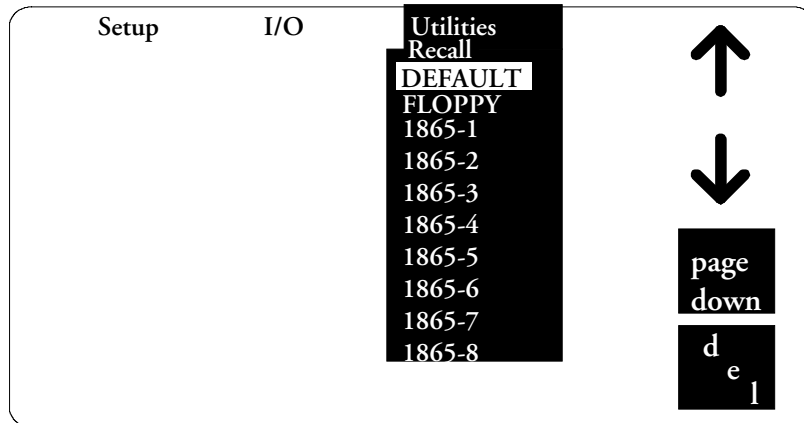

**Figure 2-25: Recall Setup Test Conditions**

Allows a previously stored set of test conditions to be recalled from instrument memory. Test conditions are those that are user programmable in the Setup and I/O menus and saved as discussed above. To recall a set of test conditions one needs to arrow down or up to the desired set. **DEFAULT** is always one of the set of test conditions that can be recalled as discussed in the previous paragraph. Selecting [**FLOPPY**] allows setups to be recalled from disk when the 3 1/2" optional drive is present. Selecting [**del**] will delete a set of test conditions and requires a Yes or No response.

When there are more setups than can fit on the display the page down key is active. If there is less than a whole page below, the display wraps around to the previous display. Continuing to page down will eventually return to the first display of setups.

**NOTE**

Setups saved using version 1.6 (or earlier) operating software can not be recalled with software 2.0 or later. The software version is shown on the display at power up.

### 2.6.4.3 Zero

The zeroing process automatically measures stray parameters and retains the data, which is used to correct measurements so that results represent parameters of the DUT alone without test lead or fixture capacitance. Zeroing is recommended at the start of each work day or more often if leads, fixture or test configuration to the DUT is changed. Zeroing should also be performed anytime the test voltage is changed, which also includes recalling a set of test conditions from memory with a different test voltage. It is important to note, that anytime the instrument is zeroed it is done at the test voltage currently specified. Once [Zero] is selected in the menu and [Enter] key pressed the operator is prompted by instructions on the display, the first is shown in Figure 2-26.

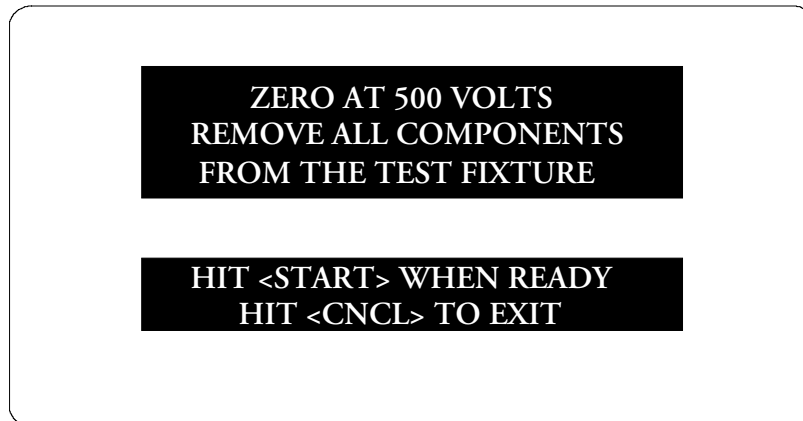

**Figure 2-26: Zeroing Procedure**

Once the zeroing is initiated by pressing [START] the next message displayed is:

ZERO CAL IN PROGRESS

Once complete, typically a minute or slightly longer, the next message displayed is:

COMPLETE  
HIT <MENU> KEY TO CONTINUE

#### 2.6.4.4 Lock Out

Allows user to turn keypad lock feature ON or OFF. There are two choices which can be selected, **lockout only** and **lockout with setup recall**. In both modes only the [START], [STOP] and [MENU] on the instrument front panel are active, all other keys disabled. The difference is that in **lockout with setup recall** the menu key also allows setups to be recalled from instrument memory.

When either is selected the operator must enter a password number up to 8 characters.

**CAUTION**

For security reasons the password is not displayed when it is entered, so the password should be keyed in distinctly and remembered.

ENTER PASSWORD  
(8 CHARACTERS MAXIMUM)

\* \* \* \* \*

Once the password is entered and entered again for verification, testing can begin by pressing [START] or the password cleared or changed by selecting [MENU].

HIT <MENU> KEY TO ENTER PASSWORD  
AND TO RETURN TO THE MENU

OR

HIT THE <START> KEY TO  
START A MEASUREMENT

Once activated, only the [START], [STOP] and [MENU] on the instrument front panel are active, all other keys are disabled. To turn the lockout feature off and reactivate menus select [MENU] (select Exit Lockout in Lockout with Setup Recall mode) and enter the previous password from the keypad, the instrument will again function as normal. Failure to remember an entered password requires an override password (186501).

If [Recall Setup] is chosen in the Lockout with Setup Recall mode, the instrument functions as described in paragraph 2.6.4.2 under Recall Setup.

#### 2.6.4.5 Calibration

Refer to Calibration in Paragraph 5.4. **INSTRUMENT CALIBRATION SHOULD ONLY BE PERFORMED BY QUALIFIED SERVICE PERSONNEL.**

#### 2.6.4.6 Set Time/Date

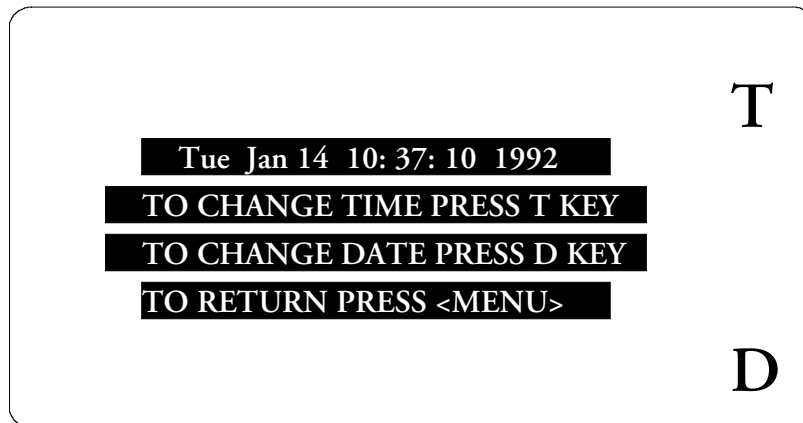

**Figure 2-28: Set Current Date and Time**

Allows resetting of time and date into unit memory. This is used as the basis for the elapsed time counter and stored calibration date.

T (time) is entered in

HOURS	(up to 2 digits, 0 through 23)
MINUTES	(up to 2 digits, 0 through 59)
SECONDS	(up to 2 digits, 0 through 59)

D (date) is entered in

MONTHS	(up to 2 digits, 1 through 12)
DAYS	(up to 2 digits, 1 through 31)
YEARS	(4 digits, 1991 through 2100)



### 2.6.4.7 Elapsed Time

When selected, indicates the total elapsed time in hours that the unit has been powered up. This is from the moment of initial use and will show some time when shipped from the factory.

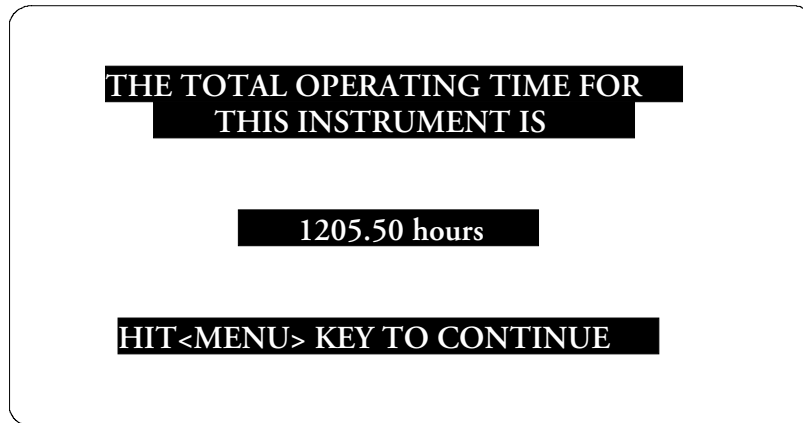

**Figure 2-29: Display of Elapsed Time**

### 2.6.4.8 Calibration Date

When selected indicates date the unit was last calibrated. This date is retained in instrument memory until the unit is re calibrated and then it is updated.

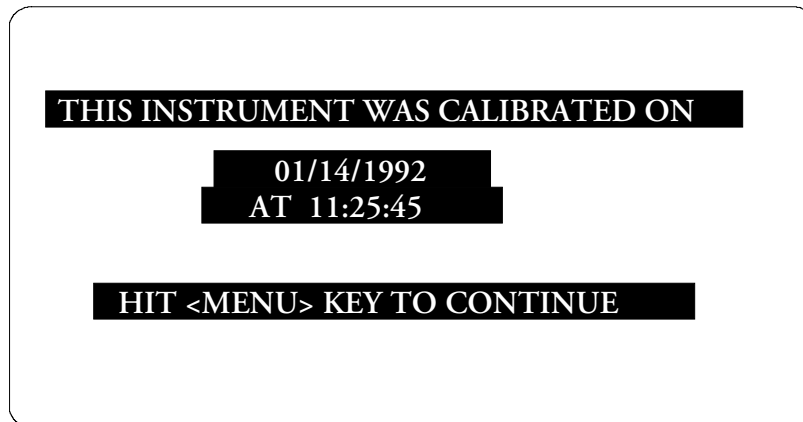

**Figure 2-30: Display of Calibration Date**

### 2.6.4.9 Set Contrast

Allows adjustment of contrast on the LCD display. Use Up arrow to increase contrast or Down arrow to decrease. When the instrument is powered up it returns to the last set contrast, not some nominal level.

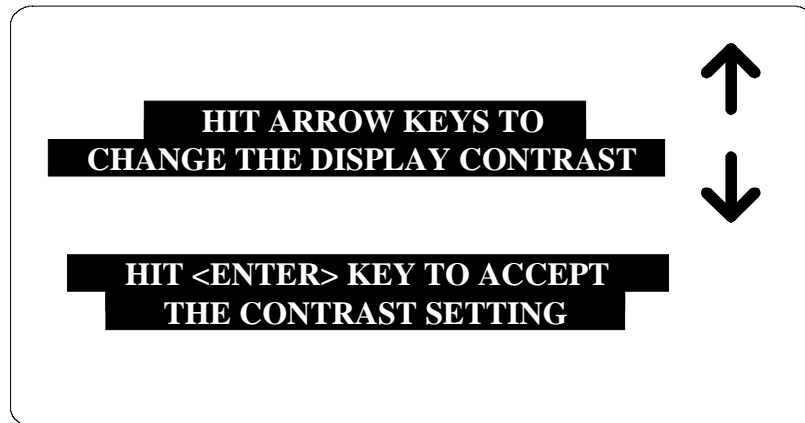

**Figure 2-31: Display Contrast Adjustment**

### 2.6.4.10 LCD Backlite

Allows the backlite on the LCD display to be turned **ON** or **OFF**. Turning the backlite off when it is not necessary or if the display is not in use will prolong the life of the display.

## 2.7 Input/Output Interface

### 2.7.1 I/O Interface

The 1865 instrument comes standard with an I/O interface port available through a connector (36 pin) on the rear panel of the instrument. This is generally used for interfacing to an automatic component handler. Refer to Table 2-3 for signal names, pin numbers and functions as necessary for cable connections.

**Table 2-3: I/O Interface Connections**

Signal Name	Pin Number	Function
<b>Input*</b>		
START	16	Initiates Measurement Cycle
<b>Outputs**</b>		
Bin 0	1	Fail, Measured Value below preset limit
Bin 1	19	Pass, Measured Value above preset limit
GND	11, 15, 33	System Ground
IGND	5, 10, 23, 28	Isolated Ground
EOT	29	End of Test, Bin signal outputs valid
TEST ACTIVE	30	Measurement in process
VCC	12, 32	+5V (Source Z: 100Ω pin12, 10Ω pin 32)
<b>Isolated Connections***</b>		
START HI (isolated)	34	High Input from external source
START LO (isolated)	35	Low Input from external source
<b>Interlock</b>		
INTERLOCK	31	Operator Safety feature primarily for use with external fixtures (i.e. operation of the 1865 instrument can be disabled until the cover of the fixture is closed). To enable the interlock function, pin 31 must be connected to ground or controlled electrically with a logic low. This can be converted to an isolated active low input by removing jumper JP4 on the I/O PCB. The interlock connector supplied with the unit makes this connection (pin 31 to 28) when plugged into the rear panel I/O connector (Figure 2-32).

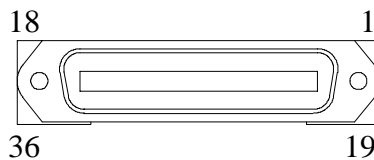

**Figure 2-32: Rear Panel I/O Connector**

**WARNING**

Do not apply an external source in excess of 5 volts with jumpers JP2, JP3 or JP4 in place, otherwise the instrument can be damaged. These jumpers are discussed below and on some instruments physically located under the stack on the I/O board.

## Table 2-3 NOTES

\* The input signal is active low and requires a positive-voltage external circuit, which must pull the signal line down below 0.4V, but not less than 0.0V, i.e. not negative. The logic-low current is 0.4mA (max). For the inactive state (logic high), the external circuit must pull the signal line above +2.5V, but not above +5V. This can be converted to a *isolated active low input* by removing jumper JP3 on the I/O PCB.

\*\* Outputs can be active low optically isolated open - collector drivers that pull each signal line to IGND (isolated common) when asserted. All outputs require a positive +5V to +24V external source (referenced to IGND) and pull-up resistor to operate as fully isolated signals. IGND can be isolated from system GND by removing jumper JP2 on the I/O PCB. With jumper JP2 in place optical isolation is defeated allowing the outputs to be pulled up to the system +5V with external resistors. The outputs can sink up to 80mA of current. Greater currents can damage the instrument.

\*\*\* Pin 34 is connected to the + input of the optical isolator through a 620Ω current limiting resistor. Pin 35 is connected to the - side of the optical isolator. Recommended force current through this circuit should be between 1 and 5mA nominal (10mA max).

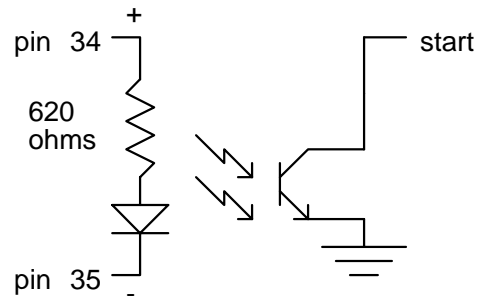

**Figure 2-33: Isolated Connection**

### 2.7.2 IEEE-488 Interface

The IEEE-488 interface is available as an option to the 1865. When this option is present connection is made through a connector (24 pin) on the rear panel. This interface can be used to connect to a system containing a number of instruments and a controller in which each meets IEEE Standard 488.2-1987 (Standard Digital Interface for Programmable Instrumentation) Refer to Table 2.4 below for a full tabulation of connections and Table 2.5 for the command set.

The following functions have been implemented. Refer to the standard for an explanation of the function subsets, represented by the identifications below.

SH1	Source Handshake	PP1	Parallel Poll	AH1	Acceptor Handshake
DC1	Device Clear	DT1	Device Trigger	SR1	Service Request
RL1	Remote Local L3		Listener	C0	Controller
E2	Electrical Interface	T5	Talker		

**Table 2-4: IEEE-488 Interface Connections**

<b>Signal Name</b>	<b>Pin Number</b>	<b>Function</b>
DAV	6	Low state: "Data is Available" and valid on DI01 through DI08
NRFD	7	Low state: At least one listener on the bus is "Not ready for Data".
NDAC	8	Low state: At least one listener on the bus is "Not Accepting Data".
ATN	11	"Attention" specifies 1 of 2 uses for the DI01 through DI08 lines Low state - Controller command messages High state - Data bytes from the talker device
IFC	9	"Interface Clear" Low state - Returns portions of interface system to a known quiescent state.
SRQ	10	"Service Request" Low state - a talker or listener signals (to the controller) need for attention in the midst of the current sequence of events
REN	17	"Remote Enable" Low state - enables each device to enter remote mode when addressed to listen High state - all devices revert to local control
EOI	5	"End of Identify" if ATN is in high state, then low state of EOI indicates end of a multiple-byte data transfer sequence. If ATN is in low state, then low state of EOI activates a parallel poll.
DI01	1	The 8-line data bus, that conveys interface messages (ATN low state) or device-dependent messages (ATN high state), such as remote-control commands from the controller or from a talker device
DI02	2	
DI03	3	
DI04	4	
DI05	13	
DI06	14	
DI07	15	
DI08	16	

**Table 2-5: IEEE and RS-232 Commands**

<b>Command</b>	<b>Function</b>	<b>Parameter(s)</b>
<b><u>CONFigure:</u></b>		
VALid?	Is filename valid to save?	XXXXXXXX
SAVE:		
DUPLicate	Save setup as duplicate filename in battery backed up RAM	XXXXXXXX
NEW	Save setup as new filename in battery backed up RAM	XXXXXXXX
RECall filename	Recall setup filename from battery backed up RAM	XXXXXXXX
FVALid?	Is filename valid to save?	XXXXXXXX
FSAVE:		
DUPLicate	Save setup as duplicate filename on floppy	XXXXXXXX
NEW	Save setup as new filename on floppy	XXXXXXXX
FRECall filename	Recall setup filename from floppy drive	XXXXXXXX
HANDler (state)	Turn handler port OFF or ON	0 (OFF) 1 (ON)
VOLTage value	Set the voltage to value	0000.000
TCHarge value	Set the charge time to value	000
TDWell value	Set the dwell time to value	000
TMEasure value	Set the measure time to value	000
TDIScharge value	Set the discharge time to value	000
MODE	Set the mode to	A (Auto) M (Manual)
RANGe	Set the range to	Auto 1mA 100uA 10uA 1uA 100nA 10nA 1nA
AVERage	Set # to average	000
LIMit value	Set the limit to value	floating point number
FRESult	Set the result format to	S (Scientific) E (Engineering)
DISPlay type	Set display type to	R (Resistance) I (Current) P (Pass/Fail) N (No Display)
SONPass	Stop on pass	000
RVALid?	Is results filename valid?	XXXXXXXX
RTOFloppy:	Results to floppy	
DUPLicate	Save results as duplicate filename on floppy	XXXXXXXX
NEW	Save results as new filename on floppy	XXXXXXXX
APPend	Append results to existing filename	XXXXXXXX
CLOSe	Close results of filename	XXXXXXXX

**Table 2-5: IEEE and RS-232 Commands (Continued)**

<b>Command</b>	<b>Function</b>	<b>Parameter(s)</b>
<b><u>SYSTem:</u></b>		
TIME	Set the time to hours, minutes	hh:mm
DATE	Set the date to month, day, year	mm/dd/yyyy
LOCKout state	Set the front panel lockout off or on	0 (Off) 1 (On)
ELAPsed?	Query the elapsed time the machine has run	
DCALibration?	Query the calibration date	

**MEASure:**

RESistance	Measure the resistance value
CURRent	Measure the current value

**FETCh?**

Fetches the most recent measurement value (with pass/fail if limit selected) for the selected parameter, resistance or current. The character sequence is as follows, terminated with a line feed: N.NNNNE+NNN (2 spaces) PASS. The plus (+) sign will be negative (-) when the parameter is selected as current. Pass can also be Fail or neither if no limit is entered.

**IDN?**

Returns instrument identification "QuadTech,1865,0,software version"

**START**

Initiates a measurement in Auto mode, in Manual mode it initiates charge, if sent again it takes one measurement, each time sent thereafter one additional measurement is taken.

**STOP**

Stops a measurement in process in Auto mode, in Manual mode it exits the measurement loop to discharge , if sent again it exits discharge.

**CALibrate:**

DATA?	Returns the calibration data to the user (21 values)*
ZERO	Instrument zero

\* Refer to Note on next page for 21 values

**Table 2-5: IEEE and RS-232 Commands (Continued)**

\* Note

Description of the 21 values returned by the remote “CAL: DATA?”

- 1 The value of the internal voltage standard
- 2 The 100 volt full scale value
- 3 The 1000 volt full scale value
- 4 The gain of the 500:1 voltage attenuator (.002)
- 5 The gain of the 50:1 voltage attenuator (.02)
- 6 The gain of the 5:1 voltage attenuator (.2)
- 7 The input resistance
- 8 The value of the range 1 standard (2KΩ)
- 9 The value of the range 2 standard (20KΩ)
- 10 The value of the range 3 standard (200KΩ)
- 11 The value of the range 4 standard (2MΩ)
- 12 The value of the range 5 standard (20MΩ)
- 13 The value of the range 6 standard (200MΩ)
- 14 The value of the range 7 standard (2GΩ)
- 15 The open circuit correction for range 1
- 16 The open circuit correction for range 2
- 17 The open circuit correction for range 3
- 18 The open circuit correction for range 4
- 19 The open circuit correction for range 5
- 20 The open circuit correction for range 6
- 21 The open circuit correction for range 7

Command	Function	Parameters
<b><u>RST</u></b> (Reset)	This command performs a device reset	
<b><u>CLS</u></b> (Clear Status)	This command clears status data structures	
<b><u>ESR?</u></b> (Event Status Register)	Sends the event status register information. This is a destructive read.	
<b><u>STB?</u></b> (Status Byte Register)	Sends user the status byte register information	
<b><u>ESE?</u></b> (Event Status Enable Register)	Sends the user event status enable register info.	
<b><u>SRE?</u></b> (Service Request Enable Register)	Sends the user service request enable register info.	
<b><u>ESE</u></b> (Event Status Enable Register)	Writes the event status enable register info.	value
<b><u>SRE</u></b> (Service Request Enable Register)	Writes the service request enable register info.	value

Status Byte Register			Event Status Register		
Bit	Decimal Value	Use	Bit	Decimal Value	Use
7	128	None	7	128	Power Up since last Query
6	64	SRQ, SPOL Resets	6	64	None
5	32	Summary Standard Event Status Register	5	32	Command Error (Syntax)
4	16	Message Available	4	16	Execution Error (Over Range, etc.)
3	8	None	3	8	No Contact
2	4	None	2	4	None
1	2	None	1	2	None
0	1	None	0	1	Operation Complete



### 2.7.3 Sample Program for National Instruments GPIB card

```
REM start with qb filename /l qbib4 ***** this is mandatory ****
REM $INCLUDE: 'qbdecl4.bas'

***** INITIALIZE 1865*****
start:
ADAP$ = "GPIB0": qt1865$ = "Dev4" 'address 4
stalp:
CALL IBFIND(qt1865$, qt1865%)
CLS ***** MEASURE AND DISPLAY DATA*****
'get the identification of the unit
  SET$ = "IDN?" '1865 setup string
  CALL IBWRT(qt1865%, SET$) 'send string to 1865
  c$ = SPACE$(25)
  CALL IBRD(qt1865%, c$) 'get data
  PRINT "unit ID is "; c$ 'print result

  SET$ = "CONF:VOLT 100" '1865 setup string
  CALL IBWRT(qt1865%, SET$) 'send string to 1865
  SET$ = "CONF:tme 0" '1865 setup string
  CALL IBWRT(qt1865%, SET$) 'send string to 1865
  SET$ = "CONF:tdw 0" '1865 setup string
  CALL IBWRT(qt1865%, SET$) 'send string to 1865
  SET$ = "CONF:tch 0" '1865 setup string
  CALL IBWRT(qt1865%, SET$) 'send string to 1865
  SET$ = "CONF:tdis 0" '1865 setup string
  CALL IBWRT(qt1865%, SET$) 'send string to 1865
  SET$ = "CONF:fres e" '1865 setup string
  CALL IBWRT(qt1865%, SET$) 'send string to 1865
  SET$ = "CONF:LIM 997000" '1865 setup string
  CALL IBWRT(qt1865%, SET$) 'send string to 1865

'make measurement
  c$ = SPACE$(18)
  SET$ = "MEAS:res" '1865 setup string
  CALL IBWRT(qt1865%, SET$) 'send string to 1865
' wait for completion of measurement
mask% = &H0800
CALL ibwait(qt1865%, mask%)
IF (ibsta% AND &HC000) <> 0 THEN PRINT "ibsta% = "; ibsta%
'get result
  SET$ = "FETC?" '1865 setup string
  CALL IBWRT(qt1865%, SET$) 'send string to 1865

  CALL IBRD(qt1865%, c$)
  PRINT "result is "; c$
'enable front panel
  SET$ = "SYSTEM:LOCK 0" '1865 setup string
  CALL IBWRT(qt1865%, SET$) 'send string to 1865

  CALL IBLOC(qt1865%): CALL IBGTS(gpib0%, V%) 'return to local control
END
```

## 2.7.4 Sample Program for IO Tech GPIB card

```
OPEN "\dev\ieeeeout" FOR OUTPUT AS #1
IOCTL #1, "BREAK"
PRINT #1, "RESET"
OPEN "\dev\ieeeein" FOR INPUT AS #2
PRINT #1, "fill error"
```

```
PRINT #1, "remote 04"
PRINT #1, "local lockout"
```

```
id$ = space$(30) : c$=space$(15)
```

```
PRINT #1, "output 04;idn?"
PRINT #1, "enter 04"
FOR i = 1 TO 3000: NEXT i
INPUT #2, id$
PRINT "Company identification is "; id$
INPUT #2, id$
PRINT "Instrument identification is "; id$
INPUT #2, id$
PRINT "Serial number is "; id$
INPUT #2, id$
PRINT "Software revision is "; id$
```

```
PRINT #1, "output 04;syst:Dcal?"
PRINT #1, "enter 04"
INPUT #2, c$
PRINT "This unit was calibrated on "; c$
```

```
PRINT #1, "output 04;conf:volt 100"
PRINT #1, "output 04;conf:lim 9.97e5"
PRINT #1, "output 04;conf:disp r"
```

```
PRINT #1, "spoll"
INPUT #2, y
IF y THEN
    PRINT #1, "spoll 04"
    INPUT #2, x : PRINT "spoll 04 = "; x
END IF
```

' an error will produce a SRQ

```
PRINT #1, "output 04;MEAS:RES"
y = 0
WHILE y = 0
PRINT #1, "spoll"
```

'SRQ at end of measurement

```

INPUT #2, y
IF y THEN
    PRINT #1, "spoll 04"
    INPUT #2, x
END IF
WEND
PRINT #1, "output 04;fetc?"           'request data
PRINT #1, "enter 04"                 'get data
INPUT #2, c$
PRINT c$

PRINT #1, "output 04;system:lock 0"  'enable front panel
PRINT #1, "local"
END

```

### 2.7.5 RS232 Interface

The 1865 instrument comes standard with an RS232 serial port interface, available through a connector (9 pin) on the rear panel of the instrument, for connecting to a PC. The RS232 standard defines electrical specifications for the transmission of bit serial information. The use of the RS232 port requires five lines: receive data, transmit data, data terminal ready, data set ready and signal ground. With some controllers additional signals maybe required and are listed in Table 2-6. Refer to Figure 2-34 for null modem cable configuration to the standard db9 or db25 connector. Refer to Table 2.5 for the command set which also applies to the RS232 interface. When using the RS-232 interface with a printer the IEEE-488 Mode must be set to **Talk** and the State to **Disable**.

**Table 2-6: RS232 Interface Connections**

Signal Name	Pin Number	Function
<b>Input:</b>		
DCD	1	Data Carrier Detect
DSR	6	Data Set Ready
RXD	2	Receive Data
CTS	8	Clear to Send
RI	9	Ring Indicator
<b>Outputs:</b>		
RTS	7	Request to Send
TXD	3	Transmit Data
DTR	4	Data Terminal Ready
GND	5	Signal Ground

### db9 to db9 Cable Configuration

1865			Controller	
Pin #	Function		Pin #	Function
2	Receive data	Connect to	3	Transmit data
3	Transmit data		2	Receive data
4	Data terminal ready		6	Data set ready
5	Signal ground		5	Signal ground
6	Data set ready		4	Data terminal ready

### db9 to db25 Cable Configuration

1865			Controller	
Pin #	Function		Pin #	Function
2	Receive data	Connect to	2	Transmit data
3	Transmit data		3	Receive data
4	Data terminal ready		6	Data set ready
5	Signal ground		7	Signal ground
6	Data set ready		20	Data terminal ready

**Figure 2-34: RS-232 Cable Configurations**

#### 2.7.6 Sample Program for RS-232

```

OPEN "com1:9600,n,8,1,rs" FOR RANDOM AS #2
'OPEN "com2:9600,n,8,1" FOR RANDOM AS #2
PRINT #2, "system:lock 1"
PRINT #2, "idn?"
GOSUB cget
r$ = INPUT$(x, #2): PRINT "idn = "; r$;
PRINT #2, "syst:dcal?"
GOSUB cget
r$ = INPUT$(x, #2): PRINT "calibration date is "; r$;

PRINT #2, "conf:fres s"
PRINT #2, "conf:tch 0"
PRINT #2, "conf:tme 0"

PRINT #2, "conf:volt 100"
FOR i = 1 TO 30000: NEXT i
gg:
PRINT #2, "meas:res"

```

'some com ports require this ie ,rs  
'others run best without ,rs  
'get unit identification  
'read serial data subroutine  
'get calibration date  
'configure unit  
'delay

```

FOR i = 1 TO 30000: NEXT i
PRINT #2, "fetc?"
GOSUB cget

s$ = INPUT$(x, #2)
PRINT "res at 100 volts is "; s$;
PRINT #2, "system:lock 0"
END

```

cget:

```

DO WHILE (LOC(2) = 0)
LOOP
y = x + LOC(2)
DO WHILE (x <> y)
y = x
FOR j = 1 TO 300: NEXT j
x = LOC(2)
LOOP
RETURN

```

' subroutine to get serial input loop  
' until first character is received  
  
' then get the rest of the string

### 2.7.7 Results to Printer

The 1865 can be setup to output to an RS-232 or IEEE printer. Results format is the same as results to floppy, refer to paragraph 2.6.3.6.

**RS-232** RS-232 must be selected on I/O Menus and format set IEEE must also be selected for Talk mode and Disable state.

**IEEE** IEEE must be selected on I/O Menus and set for Address, Talk mode and Enable state.

## 2.8 Error Messages

"BAD DRIVE-REQUEST STRUCTURE"	Floppy option not present, defective or disk not inserted
"BAD VOLTAGE SENT TO FUNCTION"	Improper voltage entered during calibration procedure
"BAD ZERO CALIBRATION"	Zeroing error, repeat and/or remove component from input terminals/fixture
"CALIBRATION STANDARD OUT OF RANGE"	Entered value > than 1% of 1 Megohm
"CORRUPT SETUP DATA"	Stored setups lost or corrupt (battery for non-volatile memory may be defective or has been disconnected)
"CRC ERROR ON FLOPPY"	Stored setup lost or corrupt (cyclic-redundancy-check)
"DISK WRITE PROTECT ERROR"	Floppy disk is write protected
"ELAPSED TIME ERROR, SET TO 0"	Elapsed time is incorrect and has been set to zero (battery for non-volatile memory may be defective or has been disconnected)
"FAILURE # SEE DOCUMENTATION"	Hardware or software failure, 1 - 99 (# list not included in this manual)
"FILE ACCESS VIOLATION"	File selected from floppy is Read Only
"FILE EXISTS"	File already exists under the chosen name
"FLOPPY DRIVE NOT READY"	Floppy option not present, defective or disk not inserted
"FLOPPY MEDIA DEFECT"	Disk defective, format or replace
"FLOPPY READ FAULT"	Floppy option not present, defective or disk not inserted
"FLOPPY SECTOR UNFORMATTED"	Floppy disk is not formatted

"FLOPPY SEEK ERROR"	Floppy option not present, defective or disk not inserted
"FLOPPY WRITE FAULT"	Floppy option not present, defective or disk not inserted
"GENERAL FAILURE, FLOPPY"	Floppy option not present, defective or disk not inserted
"HANDLER PORT FAILURE"	I/O port malfunction during power up
"HARDWARE TIMER FAILURE, REBOOT"	Hardware malfunction during power up
"INVALID CALIBRATION CODE"	Entered calibration code is invalid
"INVALID LIMIT"	Entered limit is invalid
"INTERNAL HARDWARE FAILURE, REBOOT"	Hardware malfunction during power up
"LIMIT INVALID, SET TO NONE"	No limit is accepted (out of range or invalid)
"LOW BATTERY VOLTAGE"	Memory backup battery, low voltage (setups and instrument zero could be lost)
"MAXIMUM # OF SETUPS REACHED"	Maximum number of files have been stored
"NO CALIBRATION DATA FOUND"	Calibration required (refer to ¶ 5.4)
"NO IEEE 488 INTERFACE"	Unit does not include IEEE 488 Option
"NO INTERLOCK SIGNAL"	Open interlock connection at rear panel I/O Port
"NO PASSWORD ENTERED"	Password entry canceled, re-enter
"NO SETUP DATA FOUND"	Memory backup battery has been disconnected, reset time and date
"NO ZERO DATA FOUND"	Unit requires zeroing (Refer to Utilities Menu, ¶ 2.6.4.3)
"PASSWORD DID NOT MATCH"	Incorrect password entered

"PASSWORD NOT SAVED IN RAM"	Error trying to save password, repeat
"PASSWORD VERIFICATION FAILURE"	Wrong password entry for verification
"RANGE RESISTOR VALUE OUT OF RANGE"	Malfunction of internal calibration resistors
"REMOTE COMMAND INVALID"	IEEE or RS232 command is incorrect (for example: to set voltage use VOLTage)
"REMOTE COMMAND PARAMETER INVALID"	IEEE or RS232 parameter is incorrect (for example: voltage parameter can be XXXX.XXX)
"REMOTE COMMAND PREFIX INVALID"	IEEE or RS232 command prefix is incorrect (for example: to configure unit use CONFigure)
"SHUT THE POWER OFF"	Malfunction of high voltage source
"TIME / DATE ERROR, PLEASE SET"	Reset time and date
"UNABLE TO READ FROM FLOPPY"	Floppy option not present, defective or disk not inserted
"UNABLE TO READ THAT FILENAME"	Selected file unreadable, improper format
"UNABLE TO SAVE CALIBRATION DATA"	Repeat calibration, data not stored
"UNABLE TO WRITE TO FLOPPY"	Floppy option not present, defective or disk not inserted
"UNABLE TO WRITE TO REMOTE"	IEEE or RS232 not setup correctly or IEEE option not present
"UNKNOWN UNIT"	Floppy drive is not recognized (option not present or defective)
"VALID RANGE = low value - hi value"	Entry invalid, should be between specified values
"VOLTAGE PROGRAM FAILURE"	Malfunction of instrument power supplies



---

## Section 3: Applications

---

### 3.1 Insulation Resistance Testing

Insulation resistance of materials is one of several parameters that may indicate the condition of insulation. An insulation test is to measure the resistance offered by the insulating members of a component part to an impressed direct voltage tending to produce a leakage of current through or on the surface of these members. There are times when knowledge of insulation resistance can be very important, for example; when resistance is high it may be the limiting factor in design of a high-impedance circuit, when resistance is low it can disturb the operation of circuits intended to be isolated. Insulation resistance measurements should not be considered the equivalent of a voltage breakdown test. Material with high insulation resistance could possess a mechanical fault that might fail during a voltage test and conversely material with low insulation resistance might not breakdown during a voltage test.

Factors that affect insulation resistance measurements include such things as temperature, humidity, previous conditioning, test voltage, charging current and duration of the test voltage (electrification time). It is characteristic of certain components (for example, capacitors or capacitive components or materials) for the current to fall from an instantaneous high value to a steady lower value, consequently the measured insulation resistance will increase from an appreciable time as test voltage is applied. Because of this it may take minutes to approach maximum insulation resistance readings, thus specifications usually require that readings be taken after a specified time, again electrification time. A routine test that has been widely adopted for insulation testing calls for the measurement of the apparent leakage resistance after a test voltage has been applied for 1 to 2 minutes.

For discussion on insulation resistance measurement methods and procedures refer to MIL-STD-202 and ASTM (American Society for Testing and Materials) Standard D257.

### 3.2 Test Sample Resistivity Measurements

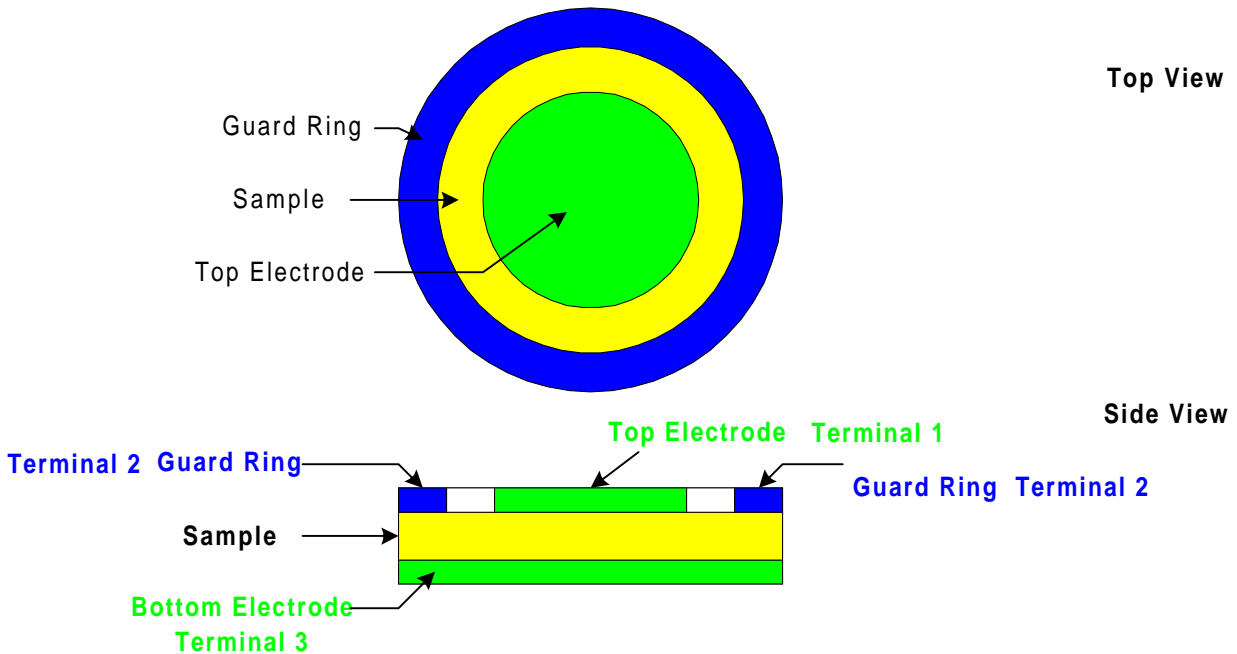

**Figure 3-1: Test Sample Cell**

The 1865 can be used for measuring the resistivity of test samples as described by ASTM Standard D 257, which describes in detail the techniques for both surface and volume resistivity measurements. The most common electrode arrangement is shown in Figure 3-1. In this configuration surface resistivity is measured with terminal 1 tied to the -UNKNOWN terminal, terminal 2 tied to the +UNKNOWN terminal and terminal 3 tied to GUARD. For volume resistivity measurements, terminal 1 is tied to the -UNKNOWN terminal, terminal 2 to the GUARD and terminal 3 to the +UNKNOWN terminal. The formulas required to convert from measured resistance to resistivity are given in the ASTM Standard.

### 3.3 Capacitor Insulation Resistance

#### 3.3.1 General

The insulation resistance measurements of capacitors is different from that of resistors by the fact that some consideration must be given to the charge and discharge currents. Consideration should also be given to high value, low leakage capacitive devices relative to dc resistance measurements. Inherent to some degree in all high resistance measurement instrumentation is the inability to provide stable leakage measurements on high value capacitors. This is due to the fact that a capacitive element is very ac sensitive and the dc voltage applied to the device always contains a small percentage of low frequency noise ripple. Measurements on pure resistive elements will tolerate a

high degree of ripple due to the voltage ratio measurements whereas a capacitor easily passes the noise ripple. When this is amplified by the current amplifier of the measuring instrument results can fluctuate and vary widely. To eliminate this in the 1865 two resistance adapters are supplied which can be placed in series with the (-) unknown (black) when measurements are made on the low current ranges (the 1MΩ, Hi Range Adapter is recommended for ranges 1nA & 10nA and the 100kΩ, Lo Range Adapter for ranges 100nA, 1nA & 10uA). This added resistance has negligible effect on the dc measurement since its value is very small compared to the leakage resistance of the unknown however it increases the ac input resistance to the current amplifier, reducing the ac gain and thus minimizing the wide fluctuations. This added resistance will have an effect on the charge time constant and is discussed briefly in paragraph 3.3.2 below.

**WARNING**

Capacitors being measured may be charged and contain lethal energy. Always make sure the **CAUTION HIGH VOLTAGE** Indicator is **OFF** when connecting or disconnecting the capacitor under test.

### 3.3.2 Charge Time Constant

The time constant for charging a capacitor in the charge phase is determined by the value of the capacitor times the effective source impedance of the supply. The supply resistance is approximately,

$$R_o = \frac{E}{I_{max}} \text{ ohms} = \frac{E}{0.002 \text{ A}} \text{ ohms} = \frac{E}{2} \text{ kohms}$$

where E is the user specified test voltage in volts and I max is the current limit of the 1865 instrument, which is approximately 2mA. Therefore, the time constant is

$$T = R_o C_x = \frac{E C_x}{2000} \text{ seconds}$$

where Cx is in μF. As an example, for a 500V test voltage Ro is approximately 250kΩ so that the time constant for charging of a 1μF capacitor is 0.25 seconds. The charge time should be set for a minimum of 10 time constants.

When the resistance adapters (discussed in paragraph 3.3.1 above) are used the time constant will be increased. In the example above if the 100kΩ or 1MΩ adapter is placed in series with the effective source impedance of 250kΩ the charge time will be increased by a factor of 0.4 and 4 respectively.

### 3.3.3 Discharge Time

The time constant for discharging a capacitor in the discharge phase is determined by the value of the capacitor times the resistance of the 1865 discharge circuit. The discharge resistance is approximately 66kΩ. The CAUTION HIGH VOLTAGE lamp is turned off after the user specified discharge time. If the discharge time is set to zero or a very short time a capacitor could remain with a charge after the indicator is extinguished. However, the discharge time is so short this is not a practical consideration except for capacitors greater than 10μF or so.

Capacitors with high dielectric absorption can have a residual charge even after they are shunted and must be repeatedly shunted to completely discharge. Usually a "voltage recovery" of this type would be a very small percentage of the original applied voltage and generally not dangerous to the operator. This risk is further minimized by the fact that the 1865 circuitry remains in a discharge mode until the operator initiates another charge and measure cycle.

### 3.4 Resistance Measurements

The recommended test voltage is typically 100V for fixed composition resistors, film resistors or wire wound resistors above 100kΩ. Refer to EIA (Electrical Industry Association) Standards. These resistors (values greater than 1000 ohms) can easily be measured on the 1865 where the instrument basic accuracy of 0.5% is adequate. For single component resistors a two terminal connection, +UNKNOWN and -UNKNOWN is recommended.

### 3.5 Measurement of Voltage Coefficient

The 1865 instrument may be used to measure voltage coefficient which is defined as :

$$\frac{R1 - R2}{R2 (V1 - V2)} \times 100\%$$

where V1 > V2

R1 is the resistance at V1, the higher voltage

R2 is the resistance at V2

For example, if V1 = 500 V and V2 = 100 V,

$$\text{Voltage Coefficient} = \frac{R_{500V} - R_{100V}}{R_{100V} (400)} \times 100\%$$

$$= \frac{1}{4} \frac{\Delta R}{R_{100V}} \%$$

This voltage coefficient is usually negative.

### 3.6 Guarded, 3-Terminal Measurements

In many cases it is necessary to measure the resistance between two points in the presence of resistance from each of these points to a third point. This third point can often be guarded to avoid error caused by the extraneous resistance. This can best be illustrated as shown in Figure 3-2 below. Here  $R_X$  is the quantity to be measured in the presence of  $R_A$  and  $R_B$ . If the junction of  $R_A$  and  $R_B$  is tied to guard,  $R_A$  is placed across the voltage source and has no effect if it is greater than  $1.25M\Omega$ . As long as  $R_B$  is greater than  $R_S$  (standard range resistor) the error caused by  $R_B$  is minimized, thus if there is a choice its better to have the higher of the two stray resistances connected to  $R_B$ .

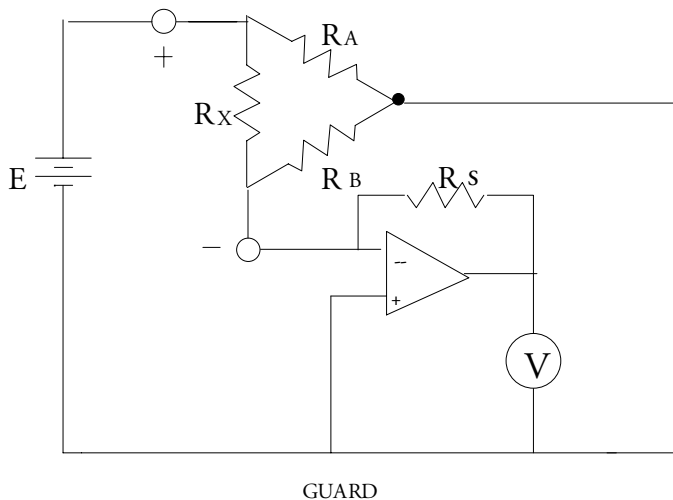

**Figure 3-2: Guarded Measurement Configuration**

The guard terminal can be used whether GUARD or the +UNKNOWN terminal is grounded, but it's important to note that if the +UNKNOWN terminal is grounded the GUARD terminal will be at a high negative voltage level. When the GUARD terminal is connected to a true ground of a device, such as chassis, it is the one that **must** be grounded, not the +UNKNOWN.



---

## Section 4: Theory

---

### 4.1 General

The 1865 Megohmmeter/IR Tester is built on QuadTech's I2000 standard instrument architecture which consists of a standard mechanical package, LCD display/keypad, microprocessor unit, digital I/O interface and power supply. The I2000 further incorporates the circuitry unique to the 1865, an analog instrument module and power supply. In addition there are two basic I2000 options, the IEEE-488 card and floppy drive/controller card. Each of these modules is discussed briefly below.

### 4.2 Instrument Description

#### 4.2.1 Basic I2000 Instrument Architecture

##### Processor Board

The processor board provides the basic control for the 1865 and mimics the IBM-PC architecture. Besides the central processing unit and memory modules it includes DOS, keypad and RS232 ports and instrument software stored in EPROM. The RS232 port is connected to its rear panel connector by a cable. The processor board is stacked on the Digital I/O Board which is mounted on the Analog Instrument board. The processor board can have the IEEE-488 and/or floppy drive controller option boards stacked on it if either or both options are present.

##### Power Supply Module

The standard I2000 power supply provides +5V which supplies power to most of the instruments basic boards/modules, including the processor board, digital I/O board, LCD display, IEEE-488 board, floppy drive and floppy drive controller board. It also provides power for the digital logic on the analog instrument board, however most power for this board is supplied by the 1865 instrument power supply module. The I2000 power supply module is located towards the rear of the instrument and the 1865 instrument power supply module towards the front.

##### Digital I/O Board

The digital I/O board provides interface to the LCD display, the keypad and provides handler interface functions through a cable to the rear panel connection. It also contains the circuitry for the instrument's many timing functions as well as a non-volatile memory used for storing test setup conditions and corrections for instrument zeroing. A battery backup for the RAM on this board is provided by 3-AA alkaline batteries which should be changed once a year. This board is mounted on the analog instrument board in the instruments main compartment. The 3 batteries are installed in the long round tube towards the rear left of the unit.

### LCD Display/Keypad Panel

The front panel user interface is comprised of a molded silicon rubber keypad that actuates a membrane switch assembly. The keypad is environmentally sealed, designed for long life and all keys with tactile feedback to the operator. The 2 1/2" x 4 3/4" LCD is a high resolution graphic display with on/off backlite for visual clarity. Both keypad and display are connected to the instrument I/O board via ribbon cables.

### **4.2.2 1865 Instrument Modules**

#### Analog Instrument Board

The analog instrument board is the heart of the 1865, it includes the measurement detector, high voltage source, and bus interface to the processor. This board also contains a non-volatile memory in EEPROM (electrically erasable programmable read only memory) for retaining vital calibration information. This is the main board in the instrument compartment to the left of the power supply modules, all other boards are mounted to it. A brief description on the operation of the measurement detector is as follows.

Figure 4-1 shows the basic block diagram for the measurement module. A programmable high voltage (0 - 1000V) is applied to the unknown component ( $R_x$ ). The current flowing through the unknown is measured by the current to voltage converter whose output ( $E_1$ ) is applied to the A/D for processing by the instruments CPU. The measured results can be expressed as  $E_1 = -(R_s/R_x)E_x$ . This technique is dependent upon the accuracy of the applied voltage source, so to improve measurement accuracy and eliminate applied voltage dependency an extra current measurement based on another set of reference standards ( $R_b/R_a$ ) is made. This measurement results can be expressed as  $E_2 = -(R_b/R_a)E_x$ . The ratio of the  $E_2/E_1$  results in the expression for the unknown  $R_x = (R_a/R_b)(R_s)(E_2/E_1)$ .

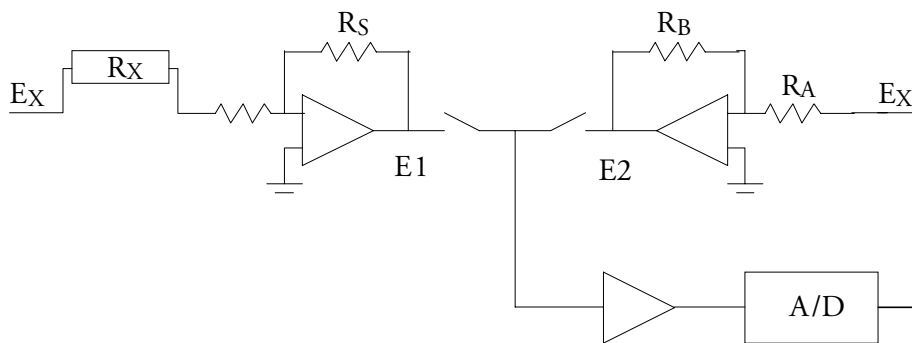

**Figure 4-1: Detector Block Diagram**



### Power Supply Module

The 1865 instrument power supply module provides +5V, +24V, and -12V. It supplies most of the power for the analog instrument board including the power source for the high voltage supply. This module is located towards the front of the unit and the standard I2000 power supply towards the rear.

### **4.2.3 I2000 Instrument Options**

#### IEEE-488 Board & Cable

The IEEE-488 board is offered as an option to the 1865 and allows complete control over all aspects of the instrument. Any user control available through the keyboard or any information available for display can be accessed over this interface. This board is mounted towards the right rear of the unit stacked above the processor board and above or below the floppy drive controller board (order of these two is not important but dependent on which option was installed last). Connection to the IEEE-488 connector on the rear panel is made by an interconnecting cable.

#### Floppy Drive

The 3.5" floppy drive is offered as an option to the 1865, for storing multiple setup conditions beyond what can be retained in the internal RAM of the unit and for storing test results. The drive will handle standard 3.5" floppies, offering 1.44Mbits of memory in DOS compatible file format, thus the setup conditions and results are readable on an IBM-PC or equivalent.

#### Floppy Drive Controller Board

A floppy drive controller card, included with the floppy drive option, provides the interface between the instrument processor and the 3.5" drive unit. This is mounted towards the right rear of the unit stacked above the processor board and above or below the IEEE-488 board (order of these two is not important). Connection to the drive unit itself is made by an interconnecting cable.



---

## Section 5: Service & Calibration

---

### 5.1 General

Our warranty (at the front of the manual) attests the quality of materials and workmanship in our products. If malfunction should be suspected, or other information be desired applications engineers are available for technical assistance. Application assistance is available in the U.S. by calling 978-461-2100 and asking for Applications Support. For support outside of the United States please contact your local QuadTech distributor.

### 5.2 Instrument Return

Before returning an instrument to QuadTech for service please call our **Customer Care Center (CCC)** at **800-253-1230** for return material authorization (RMA). It will be necessary to include a Purchase Order Number to insure expedient processing, although units found to be in warranty will be repaired at no-charge. For any questions on repair costs or shipment instructions please contact our CCC Department at the above number. To safeguard an instrument during storage and shipping please use packaging that is adequate to protect it from damage, i.e., equivalent to the original packaging and mark the box "Delicate Electronic Instrument". Return material should be sent freight prepaid, to:

QuadTech, Inc.  
5 Clock Tower Place, 210 East  
Maynard, MA 01754

Attention: RMA #

**Shipments sent collect can not be accepted.**

### 5.3 Routine Maintenance

Routine maintenance of the 1865 instrument includes battery replacement, time & date resetting, display contrast monitoring, preventative cleaning and calibration.

### 5.3.1 Battery Replacement

Backup power for the instruments non-volatile memory is supplied by 3 standard AA batteries. These should be **replaced annually with alkaline batteries**, otherwise damage to the unit is possible as a result of battery leakage. QuadTech will assume no responsibility for instrument damage resulting from the batteries not being changed as recommended. To replace the batteries proceed as follows:

1. Instrument power needs to be on but not in the measurement mode. If the batteries are removed with the power off there would be no power to the non-volatile memory and important data such as stored test conditions would be lost.
2. Place a flat head screwdriver in the groove of the battery compartment end cap and rotate counterclockwise (CCW) about 1/4 turn to remove.
3. Lift the front of the instrument up slightly so that the batteries slide out of the compartment.
4. Install three new batteries, **positive side out**.

**CAUTION**  
**Do not install the batteries backwards**

5. Reinstall the end cap and rotate clockwise (CW) to secure.

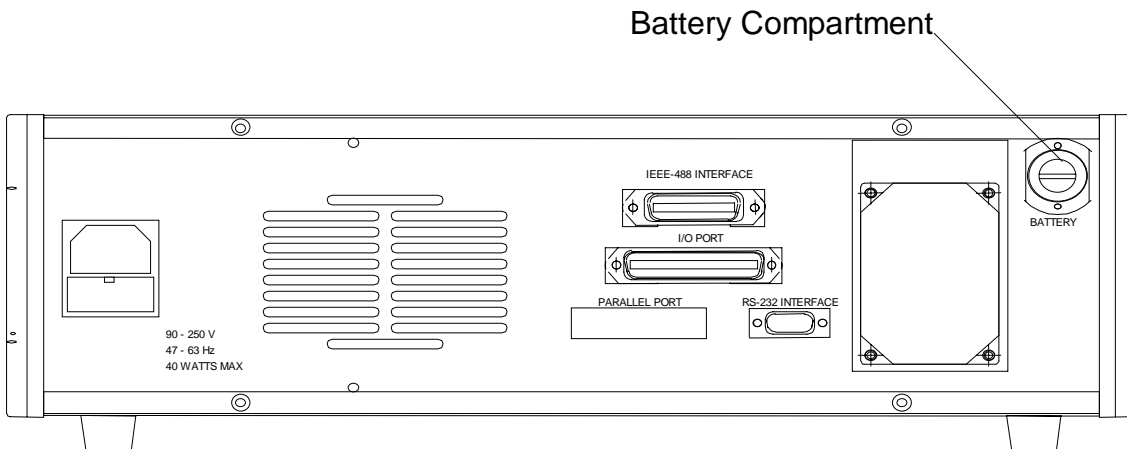

**Figure 5-1: Battery Compartment**

### 5.3.2 Resetting of Time and Date

If for some reason the backup power supplied by the 3 AA batteries should fail during shipment of the instrument (due to shock, vibration or extreme temperature) the unit will lose its zero, time and date, elapsed time and stored setup conditions. An indication of such an occurrence would be the display of the error message "ELAPSED TIME ERROR, SET TO 0" when the unit is first powered up. The most likely cause would be an intermittent connection to the battery due to shock or vibration. **It is very important that the time and date be reset and the instrument zeroed before proceeding with any measurements.** Proceed as follows:

1. Press [MENU] key to select menu display.
2. Press **Right or Left Arrow** key to select Utilities menu.
3. Press **Up or Down Arrow** key to select Set Time/Date.
4. Press [ENTER] key to activate the entry field.
5. Set the current time and date as instructed on the display, refer to paragraph 2.6.4.6 if necessary. After the time and date have been reset press [MENU] to return to the menu display.
6. Press **Up or Down Arrow** key to select Zero.
7. Press [ENTER] key to activate the Zero routine and follow instructions on the instrument display.
8. Once the Time and Date have been reset and the instrument zeroed the 1865 is ready for routine measurements. It's important to note that the elapsed time will have been reset back to zero during this process.

### 5.3.3 Loss of Display Contrast

If for some reason the instrument should lose its display contrast it is possible to reset it easily using the procedure below. **Loss of contrast would exhibit no display at all when the instrument is powered up.**

Procedure for restoring loss of contrast:

1. Consider the SELECT buttons as labeled 1, 2, 3, and 4 from top to bottom.
2. Turn the instrument on and wait 20 seconds (or after High Voltage light flashes)
3. Press [MENU] key twice.
4. Press [SELECT "4"] one time.
5. Press [SELECT "1"] two times.
6. Press [ENTER].
7. Press [SELECT "1"] many times till contrast returns to normal.
8. Press [ENTER].
9. Arrow up to [SAVE SETUP] and save as [DEFAULT].

If the above procedure fails to restore the contrast try repeating again. Failing restoration of the contrast may be indication of another instrument problem.

### 5.3.4 Preventive Maintenance/Cleaning

In addition to the annual battery replacement and calibration discussed below periodic cleaning of dust from the 3 1/3" disk drive (when this option is present) is recommended depending on the environmental conditions. Vacuuming of the drive by qualified service personnel should be done in accordance with common procedures used in computer maintenance.

## 5.4 Calibration

### 5.4.1 General

Calibration of the 1865 Megohmmeter is recommended on an annual basis. If the unit is to be returned to QuadTech for factory calibration refer to paragraph 5.2 for instructions. **Using the procedure below the instrument can also be calibrated by a qualified service person if traceable calibration equipment and standards are available.**

#### Requirements for Re calibration

Temperature stabilized room at 23 degrees C (73.4 F)

Precision Digital Voltmeter (0.01% accuracy) with calibration traceable to NIST

1 Megohm standard resistor of known value (within 0.01%) at 100V for direct connection to 1865 input terminals and traceable to NIST

### 5.4.2 Calibration Procedure

The step by step instructions for this procedure are shown on the instrument display and discussed below.

1. First set time and date by selecting [SET TIME/DATE] on the Utilities menu.
2. Select CALIBRATION on the Utilities menu. Once [ENTER] is selected the calibration code of [1][8][6][5][2][2][5] must be entered to continue. This code is to prevent unauthorized personnel from effecting the instrument calibration. The code might want to be blanked out in this manual. After the calibration code is entered the stored reference voltage is displayed and can either be accepted or measured and re-entered as instructed.

If the selection is **N** (no), measure the reference voltage as instructed between TP6 and TP8 (ground) on the analog instrument board and enter the measured value. To access these points it is necessary to remove the top cover, refer to Figure 5-1. Once this voltage value is entered and [ENTER] pressed the High Voltage (100V) will be turned on immediately.

If **Y** (yes) is selected the High Voltage (100V) will be turned on immediately.

3. Proceed to measure the voltages in each case as instructed, enter the values and press [ENTER] to continue each time. Two measurements will be made at levels of 100 and 1000V and one at 10V.
4. Short the input + and - terminals to the instrument as instructed and press [START].
5. Enter the precise known value of the 1 Mohm standard and again press [ENTER].
6. Remove the short and connect the standard between the + and - terminals.
7. When [START] is pressed a calibration measurement is made on the standard which takes approximately 25 seconds.
8. Once the standard is removed and [START] pressed again a RANGE CALIBRATION is performed which takes approximately 45 seconds.
9. Press [START], **HIGH VOLTAGE IS STILL APPLIED**, to initiate the ZERO CALIBRATION which takes approximately 75 seconds.
10. Once zero calibration is complete if the time and date are correct as displayed answer **Y** (yes) to store the calibration data. If they are not correct press **N** (no) to change date and time as instructed. To prevent the calibration from being changed by mistake the instrument requests final confirmation before the data is saved. Once this is complete and [MENU] selected the calibration is COMPLETE.